



Service Manual



PG-08 Integrated Engine Control System for GM 8.1L Engines

**2008 Emission-Certified
Non-Adjustable
Natural Gas Fuel System**

Revision 01



Limited Mechanical Warranty on New GM Powertrain Engines Manufactured by Buck's Engines Used In Industrial Applications

Terms of Coverage: Uses

This warranty applies to the first retail purchaser and subsequent owners during the WARRANTY PERIOD for new GM Powertrain Engines manufactured by Buck's Engines (referred to as Engine) that are used in industrial applications.

Defects:

This warranty covers Engine REPAIRS to correct any warranted malfunction occurring during the WARRANTY PERIOD resulting from defects in material or workmanship.

Repairs:

To obtain warranty repairs, you must request the needed repairs within the WARRANTY PERIOD from an authorized Buck's Engines service outlet. Repairs covered by this warranty must be pre-approved by a Buck's Engines authorized representative. Only new genuine parts or remanufactured parts or components supplied or approved by Buck's Engines will be used. Buck's Engines may, at its discretion, replace rather than repair components. A reasonable time must be allowed to perform the warranty repair after taking the Engine to the authorized service outlet. Repairs will be performed during normal business hours.

This Warranty Does Not Cover:

Repairs Due to Accidents, Misuse, Storage Damage, Negligence or Certain Modifications

Buck's Engines is not responsible for repairs due to improper calibration of spark, fuel, and cooling systems; misuse, negligence, accident, alterations, or applications not approved by Buck's Engines; lack of performance of required maintenance services as recommended by Buck's Engines or improper installation; or the failure to use fuel, oil, lubricants and coolant meeting Buck's Engines recommended specifications. Performance of the required maintenance services and use of proper fuel, oil, lubricants and coolant are the responsibility of the owner. See the Owner's Manual for full details.

Engine Removal and Reinstallation:

Reasonable labor costs (Maximum of 4 Hours) for Engine removal and reinstallation when necessary to make a warranty repair are covered by this warranty.

Maintenance Items:

This warranty does not cover the replacement of maintenance items (such as oil, spark plugs, ignition points, PCV valves and filters) made in connection with normal maintenance service.

Limitations:

Incidental or Consequential Damages

This warranty does not cover any economic loss, including without limitation, loss of use of the Engine or equipment, costs of substitute or replacement equipment, loss of time, inconvenience, or any other cost or expense resulting from a defect covered by this warranty.

Warranty Period:

The WARRANTY PERIOD begins on the date the Engine is delivered to the first retail purchaser or put into service, whichever occurs first. In any event, the WARRANTY PERIOD will commence no later than one year after the Engine's model year production ends. The WARRANTY PERIOD will end at the time limits shown below:

ITEM	Warranty Limitations (Whichever Occurs First)	
	MONTHS	ENGINE HOURS
Engine and Internal Moving Parts	36	3,500 Hours
Electrical Components	3	1,000 Hours
Cooling System Components	6	2,000 Hours

No Other Warranty:

THIS LIMITED WARRANTY IS THE ONLY WARRANTY APPLICABLE TO THESE ENGINES. BUCK'S ENGINES MAKES NO OTHER WARRANTIES EXPRESS OR IMPLIED.

September 2010

UE Powertrain LP, d/b/a Buck's Engines - 20 N. McCormick - Oklahoma City, Oklahoma 73127

WARNING—DANGER OF DEATH OR PERSONAL INJURY



WARNING—FOLLOW INSTRUCTIONS

Read this entire manual and all other publications pertaining to the work to be performed before installing, operating, or servicing this equipment. Practice all plant and safety instructions and precautions. Failure to follow instructions can cause personal injury and/or property damage.

WARNING—OVERSPEED PROTECTION

The engine, turbine, or other type of prime mover should be equipped with an overspeed shutdown device to protect against runaway or damage to the prime mover with possible personal injury, loss of life, or property damage.

The overspeed shutdown device must be totally independent of the prime mover control system. An overtemperature or overpressure shutdown device may also be needed for safety, as appropriate.



WARNING—PROPER USE

Any unauthorized modifications to or use of this equipment outside its specified mechanical, electrical, or other operating limits may cause personal injury and/or property damage, including damage to the equipment. Any such unauthorized modifications: (i) constitute "misuse" and/or "negligence" within the meaning of the product warranty thereby excluding warranty coverage for any resulting damage, and (ii) invalidate product certifications or listings.



CAUTION—POSSIBLE DAMAGE TO EQUIPMENT OR PROPERTY



CAUTION—BATTERY CHARGING

To prevent damage to a control system that uses an alternator or battery-charging device, make sure the charging device is turned off before disconnecting the battery from the system.



CAUTION—ELECTROSTATIC DISCHARGE

Electronic controls contain static-sensitive parts. Observe the following precautions to prevent damage to these parts.

- Discharge body static before handling the control (with power to the control turned off, contact a grounded surface and maintain contact while handling the control).
- Avoid all plastic, vinyl, and Styrofoam (except antistatic versions) around printed circuit boards.
- Do not touch the components or conductors on a printed circuit board with your hands or with conductive devices.

IMPORTANT DEFINITIONS

- A **WARNING** indicates a potentially hazardous situation which, if not avoided, could result in death or serious injury.
- A **CAUTION** indicates a potentially hazardous situation which, if not avoided, could result in damage to equipment or property.
- A **NOTE** provides other helpful information that does not fall under the warning or caution categories.

Buck's Engines reserves the right to update any portion of this publication at any time. Information provided by Buck's Engines is believed to be correct and reliable. However, no responsibility is assumed by Buck's Engines unless otherwise expressly undertaken.

Contents

REGULATORY COMPLIANCE	6
EPA / CARB Emissions Certification	6
North American Compliance.....	6
ELECTROSTATIC DISCHARGE AWARENESS.....	7
CHAPTER 1. SYSTEM OVERVIEW	8
PG-08 General Description.....	8
PG-08 System Components.....	10
Key Components	10
PG-08 System Features	10
Natural Gas Fuel System Operation.....	12
PG-08 Electric Fuel Lock-Off.....	12
Fuel Filter	13
Maxitrol 210DZ Pressure Regulator	14
D100 Mixer.....	15
Electronic Throttle System.....	16
PG-08 Electronic Throttle	16
Ignition System	18
General Motors (GM) Coil Near Plug Ignition System	18
Exhaust System.....	20
Catalytic Converter	20
SECM	22
Fuel Management.....	22
Speed Management.....	23
SECM / Sensors	24
Analog Inputs	24
Frequency/Position Inputs	24
Digital Inputs	25
Outputs	25
CHAPTER 2. SPECIFICATIONS	26
Fuel System Requirements	26
Environmental / Electrical Specifications.....	26
210DZ Pressure Regulator Specifications.....	26
D100 Mixer Specifications	27
Electronic Throttle System Specifications	27
SECM Specifications	27
Fuel Trim Valve (FTV) Specifications	28
Ignition System Specifications	28
Chapter 3. Recommended Maintenance.....	29
Maintenance Tests & Inspections.....	29
Test Fuel System for Leaks	29
Inspect Engine for Fluid Leaks	29
Inspect Vacuum Lines and Fittings.....	29
Inspect Electrical System.....	29
Inspect Coolant Hoses.....	30
Inspect Battery System	30
Inspect Ignition System.....	30
Replace Spark Plugs	30
Testing Fuel Lock-off Operation	30
Pressure Regulator Inspection	30
Fuel Trim Valve Inspection (FTV).....	31
Inspect Mixer Assembly.....	31
Inspect for Intake Leaks.....	31
Inspect Throttle Assembly	31

Checking the TMAP Sensor	31
Inspect Engine for Exhaust Leaks	31
Maintenance Schedule	32
CHAPTER 4. INSTALLATION PROCEDURES	34
Removal and Installation of 210DZ Regulator	35
Removal and Installation of D100 Mixer	36
CHAPTER 5. TESTS AND ADJUSTMENTS	38
210DZ Regulator Service Testing.....	38
Connection of PG-08 Service Tool	40
Chapter 6. Basic Troubleshooting	41
Preliminary Checks.....	41
Basic Troubleshooting	42
Intermittents	42
Surges and/or Stumbles	43
Engine Cranking but Will Not Start / Difficult to Start.....	44
Lack of Power, Slow to Respond / Poor High Speed Performance / Hesitation During Acceleration.....	46
Detonation / Spark Knock	48
Backfire	49
Dieseling, Run-on	49
Rough, Unstable, Incorrect Idle, or Stalling	50
Cuts Out, Misses	52
Poor Fuel Economy / Excessive Fuel Consumption Natural Gas Exhaust Smell.....	53
High Idle Speed	54
Excessive Exhaust Emissions or Odors	55
Diagnostic Aids for Rich / Lean Operation.....	56
Chart T-1 Restricted Exhaust System Check	57
CHAPTER 7. ADVANCED DIAGNOSTICS.....	58
Reading Diagnostic Fault Codes	58
Displaying and Clearing Fault Codes (DFC) from SECM Memory	58
Fault Action Descriptions	59
Fault List Definitions.....	60
Table 1. Fault List Definitions.....	60
Table 2. Diagnostic Fault Codes (Flash Codes)	67
CHAPTER 8. PARTS DESCRIPTION.....	81
Fuel System Components	81
Maxitrol 210DZ Regulator.....	82

List of Figures

Figure 1. PG-08 System for GM 8.1L Natural Gas Engines.....	8
Figure 2. PG-08 Closed Loop NG Fuel System.....	9
Figure 3. Maxitrol 210DZ Regulator.....	14
Figure 4. D100 Mixer	15
Figure 5. D100 Mixer Attached to Throttle Body.....	15
Figure 8. Bosch Electronic Throttle Body	16
Figure 9. Throttle Body Assembly Exploded View	17
Figure 10. HEGO (O2) Sensor	20
Figure 11. Throttle Position Sensor (TPS) on DV-E5 Throttle.....	23
Figure 15. 210DZ Regulator	35
Figure 16. D100 Mixer Installed on Engine.....	36
Figure 17. Wire Harness Connector on Throttle Body.....	37
Figure 19. Regulator Pressure Test Connections	38
Figure 21. KVaser Communication Adapter	40
Figure 22. Crypt Token Installed on Laptop.....	40
Figure 23. Opening the Service Tool Display	40
Figure 26. Installing Exhaust Backpressure Tester	57

Regulatory Compliance

EPA / CARB Emissions Certification

When properly applied and calibrated, Buck's Engines' PG-08 control system meets EPA 2008 stationary emission standards for rich-burn natural gas (40 CFR Part 60) when operating properly with an approved three-way catalyst. The emissions test is based on the ISO 8178 type D2 steady-state test cycle. The emission standards, including appropriate deterioration factors over the useful life of the system, are as follows:

When operating on natural gas, 8000 hour deteriorated emissions shall be less than or equal to:

NMHC:	1.0 g/hp-hr
CO:	4.0 g/hp-hr
NOx:	2.0 g/hp-hr

The PG-08 control system complies with New Source Performance Standards (NSPS) and National Emission Standards for Hazardous Air Pollutants (NESHAP) proposed by the EPA. These standards are effective in 2008 for stationary spark-ignited engines.

As defined in applicable regulations, the engine control system is designed to maintain emissions compliance for ten (10) years or 8000 hours, whichever occurs first, provided appropriate maintenance is performed as defined in the service manual for the system. Maintenance intervals shall be defined and approved by the regulating body. Component warranty shall comply with regulatory requirements (40 CFR Part 1048.120) for all emission related components. Warranty for non-critical emissions components will be as defined in the individual purchase agreement.

North American Compliance

The 210DZ regulator is UL listed per Category MIMV2.

The 210DZ regulator has tamper-resistant features approved by the California Air Resources Board (CARB) *when used with commercial grade fuel.*

Electrostatic Discharge Awareness

All electronic equipment is static-sensitive, some components more than others. To protect these components from static damage, you must take special precautions to minimize or eliminate electrostatic discharges.

Follow these precautions when working with or near the control.

1. Before doing maintenance on the electronic control, discharge the static electricity on your body to ground by touching and holding a grounded metal object (pipes, cabinets, equipment, etc.).
2. Avoid the build-up of static electricity on your body by not wearing clothing made of synthetic materials. Wear cotton or cotton-blend materials as much as possible because these do not store static electric charges as much as synthetics.
3. Keep plastic, vinyl, and Styrofoam materials (such as plastic or Styrofoam cups, cup holders, cigarette packages, cellophane wrappers, vinyl books or folders, plastic bottles, and plastic ash trays) away from the control, the modules, and the work area as much as possible.

Chapter 1. System Overview

PG-08 General Description

Buck's Engines' emission-certified PG-08 control system provides a complete, fully integrated engine management system that helps OEMs and packagers comply with New Source Performance Standards (NSPS) proposed by the Environmental Protection Agency (EPA). These standards are effective in 2008 for stationary spark-ignited engines.

The control system is applicable to naturally aspirated engines ranging in size from 1.6L to 8.1L (25 to 220 HP [18.64 to 164 kW]) with up to 8 cylinders running on natural gas in stationary industrial applications.

It provides accurate, reliable, and durable control of fuel, spark, and air over the service life of the engine in the extreme operating environment found in heavy-duty, under hood, on-engine electronic controls.

PG-08 is a closed loop system utilizing a catalytic converter to reduce the emission level in the exhaust gas. In order to obtain maximum effect from the catalyst, an accurate control of the air fuel ratio is required. A small engine control module (SECM) uses two heated exhaust gas oxygen sensors (HEGO) in the exhaust system to monitor exhaust gas content. One HEGO is installed in front of the catalytic converter and one is installed after the catalytic converter.

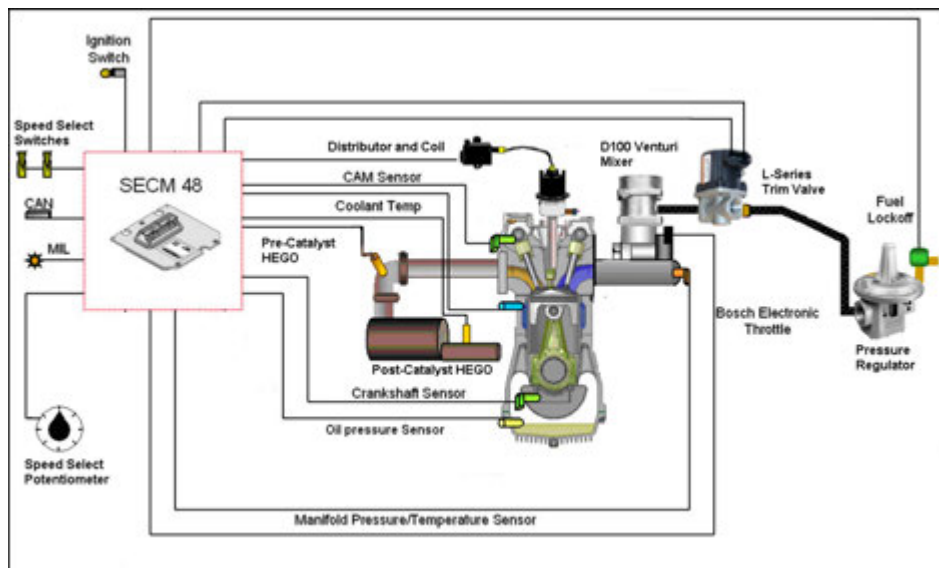

Figure 1. PG-08 System for GM 8.1L Natural Gas Engines

The SECM makes any necessary corrections to the air fuel ratio by controlling the inlet fuel pressure to the air/fuel mixer by controlling the position of the L-Series fuel trim valve. Closing the valve leans the air/fuel mixture and opening the valve enriches the air/fuel mixture. To calculate any necessary corrections to the air fuel ratio, the SECM uses a number of different sensors to gain information about the engine's performance. Engine speed is monitored by the SECM through a

variable reluctance (VR) or Hall Effect sensor. Intake manifold air temperature and absolute pressure are monitored with a TMAP sensor. PG-08 is a drive-by-wire (DBW) system connecting the accelerator pedal to the electronic throttle through the electrical harness; mechanical cables are not used. A throttle position sensor (TPS) monitors throttle position in relation to the accelerator pedal position sensor (APP) command. Even engine coolant temperature and adequate oil pressure are monitored by the SECM. The SECM controller has full adaptive learning capabilities, allowing it to adapt control function as operating conditions change. Factors such as ambient temperature, fuel variations, ignition component wear, clogged air filter, and other operating variables are compensated.

PG-08 Closed Loop Natural Gas Fuel System

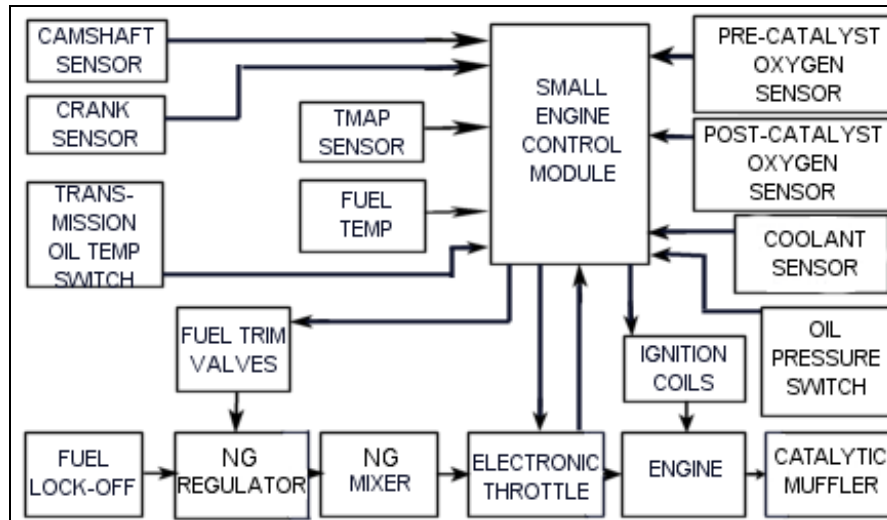

Figure 2. PG-08 Closed Loop NG Fuel System

PG-08 System Components

The PG-08 control system provides electronic control to the following subsystems on stationary industrial engines:

- Fuel delivery system
- Spark-ignition control system
- Air throttle
- Sensors/Switches/Speed inputs

Key Components

The PG-08 system functions primarily on engine components that affect engine emissions and performance. These key components include the following:

- Engine/Combustion chamber design
- Intake/Exhaust valve configuration, timing and lift
- Intake/Exhaust manifold design
- Catalytic converter and exhaust system
- Throttle body
- Air intake and air filter
- Gaseous fuel mixer
- Gaseous fuel pressure regulator
- Fuel trim valve
- Small engine control module (SECM), firmware and calibration
- Fuel system sensors and actuators
- Ignition system including spark plugs, cables, coils and drivers

PG-08 System Features

The PG-08 system uses an advanced speed-density control strategy for fuel, spark, and air throttle control. Key features include the following.

- Speed-load spark control with tables for dwell, timing, and fuel type
- Speed-load throttle control with table for maximum TPS limiting
- Closed-loop fuel control with two oxygen sensors (one installed pre catalyst and one installed post catalyst). The pre-catalyst oxygen sensor includes adaptive learn to compensate for fuel or component drift. The post-catalyst oxygen sensor includes adaptive learn to compensate the pre-catalyst oxygen sensor setting for pre-catalyst oxygen sensor drift and catalyst aging. The pre-catalyst oxygen sensor function includes parameters for transport delay, O₂ set point, excursion rich/lean, jump back rich/lean, and perturbation.
- Min/max governing
- All-speed isochronous governing
- Fixed-speed isochronous governing with three switch-selectable speeds
- Fuel enrichment and spark timing modifiers for temperature and fuel type
- Transient fuel enrichment based on rate of change of TPS
- Input sensor selection and calibration

- Auxiliary device control for fuel pump, fuel lock-off solenoid, MIL, interlocks, engine speed limiting, etc.
- CANBus data transfer for speed, torque, etc.

Other System Features Include:

Tamper-Resistance

(Applications Using Commercial Grade Fuel)

Special tools, equipment, knowledge, and authorization are required to effect any changes to the PG-08 system, thereby preventing unauthorized personnel from making adjustments that will affect performance or emissions.

Diagnostics

PG-08 is capable of monitoring and diagnosing problems and faults within the system. These include all sensor input hardware, control output hardware, and control functions such as closed-loop fuel control limits and adaptive learn limits. Upon detecting a fault condition, the system notifies the operator by illuminating the MIL and activating the appropriate fault action. The action required by each fault shall be programmable by the OEM at the time the engine is calibrated.

Diagnostic information can be communicated through both the Service Tool interface and the MIL lamp. With the MIL lamp, it is possible to generate a string of flashing codes that correspond to the fault type. These diagnostics are generated only when the engine is not running and the operator initiates a diagnostic request sequence such as repeated actuations of the pedal within a short period of time following reset.

Service Tool

A scan tool/monitoring device is available to monitor system operation and assist in diagnosis of system faults. This device monitors all sensor inputs, control outputs, and diagnostic functions in sufficient detail through a single access point to the SECM to allow a qualified service technician to maintain the system. This MotoService software (licensed by MotoTron Corporation) is secure and requires a crypt-token USB device to allow access to information.



NOTE

It is the responsibility of the customer to consult with Buck's Engines regarding the selection or specification of any components that impact emissions, performance, or durability.

Natural Gas Fuel System Operation

The principles outlined below describe the operation of PG-08 on a natural gas fuel system.

A natural gas fuel system consists of the following components:

- Fuel filter (supplied by customer)
- Electric fuel vapor lock-off solenoid valve
- Fuel pressure regulator
- Twin orifice fuel trim valves
- Gas/air mixer
- Miscellaneous hoses and fittings

Fuel passes through a lock-off valve, and is then regulated down to the appropriate pressure to supply the mixer. The regulator controls the fuel pressure to the gas/air mixer. In some cases, a primary regulator is required to bring the supply pressure down to 8-15 inH₂O before the PG-08 fuel pressure regulator stage.

L-Series Fuel Trim Valve

The key to meeting emissions requirements when operating on natural gas is the L-Series trim valve in the fuel system. The L-Series fuel trim valve used in the PG-08 system is configured as a positioner and will go to a position that is commanded via a pulse-width modulated signal. The L-Series trim valve controls fuel delivery by providing a restriction in the fuel line prior to entering the mixer. The valve controls the restriction by moving to a commanded position based on feedback from the SECM.

SECM

The Small Engine Control Module (SECM) controls the natural gas lock-off solenoid valve and the FTV. The lock-off valve is energized when fueling with natural gas and the engine is turning. FTV commands will be altered by the SECM in order to maintain a stoichiometric air-fuel ratio. Commands are based primarily on feedback from the exhaust gas oxygen sensor.

PG-08 Electric Fuel Lock-Off

The fuel lock-off is a safety shutoff valve, normally held closed by spring pressure, which is operated by an electric solenoid and prevents fuel flow to the regulator when the engine is not in operation.

In the PG-08 design, power is supplied to the fuel lock-off via the main power relay with the SECM controlling the lock-off ground (earth) connection. The lock-off remains in a normally closed (NC) position until the key switch is activated. This supplies power to the lock-off and the SECM, but will not open the lock-off via the main power relay until the SECM provides the lock-off ground connection. This design gives the SECM full control of the lock-off while providing additional safety by closing the fuel lock-off in the unlikely event of a power failure, wiring failure or module failure.

When the fuel supply service valve is opened, natural gas flows through the service line to the fuel lock-off. Natural gas enters the lock-off through the inlet port and stops with the lock-off in the normally closed position. When the engine is cranked over the main power relay applies power to the lock-off and the SECM provides the lock-off ground causing current to flow through the windings of the solenoid creating a magnetic field. The strength of this magnetic field is sufficient to lift the lock-off valve off of its seat against spring pressure. When the valve is open natural gas, at line pressure, flows through the lock-off outlet to the pressure regulator. A stall safety shutoff feature is built into the SECM to close the lock-off in case of a stall condition. The SECM monitors three engine states: *Crank*, when the crankshaft position sensor detects any engine revolutions; *Stall*, when the key is in the ON position but the crankshaft position sensor detects no engine revolutions; and the *Run* state, when the engine reaches pre-idle rpm. When an operator turns on the key switch the lock-off is opened, but if the operator fails to crank the engine the SECM will close the lock-off after approximately 5 seconds.

Fuel Filter

A fuel filter should be placed in the fuel line upstream from the fuel lock-off. The fuel filter protects fuel system components from particulates and other contaminants that may be present in the fuel.



NOTE

For system durability a fuel filter should be installed upstream of the lock-off. The filter should be 10 micron or better at 99% efficiency. Failure to use a filter may result in reduced system performance and durability.

Maxitrol 210DZ Pressure Regulator

The pressure regulator receives gaseous natural gas from the supply line (8-15 inH₂O) [37.3–76.7 mbar]. It drops the pressure and provides vapor phase natural gas at a regulated outlet pressure to the trim valve. The outlet pressure of the regulator will be approximately equal to the pressure of the air entering the venturi mixer.



Figure 3. Maxitrol 210DZ Regulator

Regulator Operation

Natural gas, at line pressure, enters the 210DZ through the fuel inlet port.

The regulating valve is at a fixed position that is determined by the setting of the screw on top of the regulator when no gas is flowing. When the fuel lock-off is opened fuel will flow into the inlet and straight through the regulator. If there is no fuel demand the outlet pressure will increase, causing a force imbalance on the valve/diaphragm that will close the valve. When the engine is running the valve will open to maintain the outlet pressure at the setting commanded by the system. The valve will open wider for higher fuel flow demands and will close for lower fuel flow demands.

D100 Mixer

The mixer is installed above the throttle body and meters gaseous fuel into the airstream at a rate that is proportional to the volumetric flow rate of air. The ratio between volumetric airflow and volumetric fuel flow is controlled by the size of the metering orifices inside the venturi and biased by the restriction in the fuel supply line provided by the L-Series trim valve. Fuel flow must be metered accurately over the full range of airflows. Pressure drop across the mixer air valve must be minimized to assure maximum power output from the engine.



Figure 4. D100 Mixer

D100 Venturi Mixer Operation

Vapor natural gas fuel is supplied to the D100 mixer by the Maxitrol 210DZ pressure regulator. When air enters the mixer the pressure will drop at the throat of the mixer. This reduction in air pressure creates a pressure imbalance across the fuel metering orifices. The fuel on one side of the orifices is at a higher pressure than the air on the other side and as a result, fuel will flow across the orifices into the airstream. The amount of fuel flow depends on the fuel pressure at the orifices and the size of the orifices. The air/fuel mixture then travels past the throttle, through the intake manifold and into the engine cylinders where it is compressed, ignited and burned.



Figure 5. D100 Mixer Attached to Throttle Body

Electronic Throttle System

PG-08 Electronic Throttle

Conventional throttle systems rely on a mechanical linkage to control the throttle valve. To meet fluctuating engine demands a conventional system will typically include a throttle valve actuator designed to readjust the throttle opening in response to engine demand, together with an idle control actuator or idle air bypass valve.

In contrast, the PG-08 system uses electronic throttle control (ETC). The SECM controls the throttle valve based on engine RPM, engine load, and information received from the speed input device.

The PG-08 system uses a Bosch electronic throttle body DV-E5 in the following sizes:

- (a) 32mm for 1.6L and 2.4L engines
- (b) 40mm for 3.0L and 4.3L engines
- (c) 60mm for 5.7L engines
- (d) 68mm for 8.1L engines

The DV-E5 is a single unit assembly, which includes the throttle valve, throttle-valve actuator (DC motor), and two throttle position sensors (TPS). The SECM calculates the correct throttle valve opening that corresponds to the engine's demand, makes any adjustments needed for adaptation to the engine's current operating conditions and then generates a corresponding electrical (driver) signal to the throttle-valve actuator.



Figure 8. Bosch Electronic Throttle Body

The PG-08 system uses a dual TPS design (TPS1 and TPS2). The SECM continuously checks and monitors all sensors and calculations that effect throttle valve position whenever the engine is running. If any malfunctions are encountered, the SECM's initial response is to revert to redundant sensors and calculated data. If no redundant signal is available or calculated data cannot solve the malfunction, the SECM will drive the system into one of its limp modes or shut the engine down, storing the appropriate fault information in the SECM.

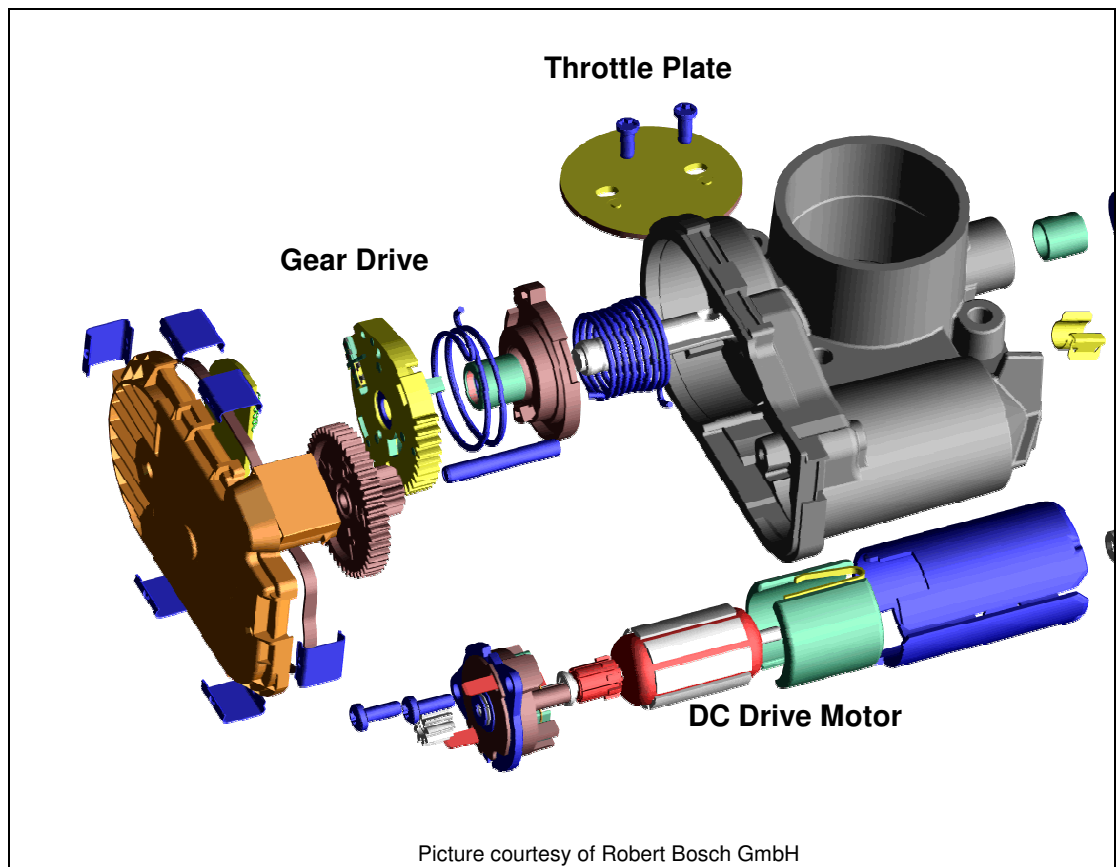

Figure 9. Throttle Body Assembly Exploded View

Ignition System

Spark-ignited engines require accurate control of spark timing and spark energy for efficient combustion. The PG-08 ignition system provides this control. The system consists of the following components:

- SECM
- Ignition coils
- Crankshaft position sensor
- Crankshaft timing wheel
- Camshaft position sensor
- Camshaft timing wheel
- Spark plugs

The SECM, through use of embedded control algorithms and calibration variables, determines the proper time to start energizing the coil and fire the spark plug. This requires accurate crank/camshaft position information, an engine speed calculation, coil energy information, and target spark timing. The SECM controls spark energy (dwell time) and spark discharge timing.

General Motors (GM) Coil Near Plug Ignition System

The GM 8.1L engine has a coil near plug ignition system. The engine comes equipped with eight coils (one per cylinder) that are mounted near each cylinder. A high tension ignition wire connects the output of each coil to the spark plug in each cylinder.

The coils provided with the GM 8.1L engine provide a control interface that allows external control modules to control engine timing and dwell. When the SECM sends a 5-volt signal to the control interface, the coil control module begins charging the coil. When the SECM signal returns to the ground state, the coil discharges into the spark plug. In this way, the amount of time the SECM signal is in the high state determines the coil dwell. The moment that the signal returns to the ground state determines when the spark plug fires.

The SECM uses the crankshaft position sensor to determine the ignition timing, so timing adjustments cannot be made.

IGNITION SYSTEM COMPONENTS

In a coil near plug ignition system, crankshaft and camshaft position sensors generate a basic timing signal by reading notches on the crankshaft, flywheel, or harmonic balancer and camshaft.

The crank and cam sensor signals go to the small engine control module (SECM), where they are used to determine firing order and turn the individual ignition coils on and off.

The operation of the ignition system is essentially the same as any other ignition system. The coil has a low primary resistance (0.4 to 0.6 ohms) and steps up the primary system voltage from 12 volts to as much as 40,000 volts to produce a

spark for the spark plug. Resistor spark plugs are generally used to suppress electromagnetic interference (EMI).

MISFIRES

Common ignition system ailments include misfiring, hard starting, or a no start. Spark plugs can still be fouled by oil or fuel deposits, as well as pre-ignition and detonation.

If the crankshaft or camshaft position sensors fail, the loss of the basic timing signal will prevent the system from generating a spark and the engine will not start or run. A failed driver circuit within the SECM will also prevent proper ignition system operation.

It is important to remember that ignition misfire can also be caused by other factors such as worn or fouled spark plugs, loose or damaged coil connector or terminals, low fuel pressure, intake vacuum leaks, loss of compression in a cylinder, or even contaminated fuel. These other possibilities should all be ruled out before coils are replaced.

A SECM controlled engine that cranks but fails to start, in many cases, will often have a problem in the crankshaft or camshaft position sensor circuits. Loss of sensor signals may prevent the SECM from properly synchronizing, thereby preventing the engine from starting and running.

IGNITION SYSTEM CHECKS

The ignition coils can be tested with an ohmmeter. Measure primary and secondary resistance and compare to specifications. If resistance is out of specifications, the coil is bad and needs to be replaced.

Also, pay close attention to the tube that wraps around the spark plug. Cracks can allow voltage to jump to ground causing a misfire. The spark plug terminal should also fit tightly.

If a coil tests bad and is replaced, cleaning the connector and wiring harness terminals of the coil can often avoid future problems. Corrosion at either place can cause intermittent operation and loss of continuity, which may contribute to component failure. Applying dielectric grease to these connections can help prevent corrosion and assure a good electrical connection.

Exhaust System

Heated Exhaust Gas Oxygen Sensors (HEGO)

The PG-08 system utilizes two HEGO (O₂) sensors. One sensor is a pre-catalyst sensor that detects the amount of oxygen in the exhaust stream and is considered the primary control point. Based upon the O₂ sensor feedback, the PG-08 system supplies a stoichiometric air-fuel ratio to the catalytic converter. The catalytic converter then reduces emissions to the required levels. The second sensor is a post-catalyst sensor that detects the amount of oxygen after the catalyst. This sensor is used as a secondary control point to adjust the pre-catalyst setpoint to ensure proper catalyst conversion efficiency.

Once a HEGO sensor reaches approximately 600°F (316°C), it becomes electrically active. The concentration of oxygen in the exhaust stream determines the voltage produced. If the engine is running rich, little oxygen will be present in the exhaust and voltage output will be relatively high. Conversely, in a lean situation, more oxygen will be present and a smaller electrical potential will be noticed.



Figure 10. HEGO (O₂)

Sensor

In order for the sensor to become active and create an electrical signal below 600°F (316°C) a heated element is added to the sensor housing. Two wires provide the necessary 12 Vdc and ground signal for the heater element. A fourth wire provides an independent ground for the sensor. The pre-catalyst sensor heater is powered by the main power relay and is always powered. The post-catalyst sensor heater is powered from an additional relay that is controlled by the SECM. This relay is only energized when the SECM calculates that water condensation in the exhaust system and catalytic converter prior to the sensor should be evaporated. This is to avoid thermal shock of the sensor that could prematurely fail the sensor.

The HEGO stoichiometric air-fuel ratio voltage target is approximately 500 mV and changes slightly as a function of speed and load. When the pre-catalyst HEGO sensor sends a voltage signal less than 450 mV the SECM interprets the air-fuel mixture as lean. The SECM then decreases the PWM duty cycle sent to the fuel trim valves in order to increase the fuel pressure to the mixer inlet; thus richening air-fuel mixture. The opposite is true if the SECM receives a voltage signal above 450 mV from the HEGO. The air-fuel mixture would then be interpreted as being too rich and the SECM would increase the duty cycle of the trim valves.



CAUTION

The HEGO sensors are calibrated to work with the PG-08 control system. Use of alternate sensors may impact performance and the ability of the system to diagnose rich and lean conditions.

Catalytic Converter

In order to meet 2008 emission requirements a 3-way catalyst is necessary.

The PG-08 control system monitors the exhaust stream pre and post catalyst and uses this information to control the air-fuel mixture. By using the signals from the HEGOs, the SECM can increase or decrease the amount of oxygen in the

exhaust by modulating the FTV and adjusting the air-fuel ratio. This control scheme allows the SECM to make sure that the engine is running at the correct air to fuel ratio so that the catalyst can perform as required to meet the emissions certification.

SECM

The Small Engine Control Module (SECM) controller has full authority over spark, fuel and air. Utilizing a Freescale micro controller, the SECM has 48 pins of I/O and is fully waterproof and shock hardened. To optimize engine performance and drivability, the SECM uses several sensors for closed loop feedback information. These sensors are used by the SECM for closed loop control in three main categories:



- Fuel Management
- Load/Speed Management
- Ignition Management

The SECM monitors system parameters and stores any out of range conditions or malfunctions as faults in SECM memory. Engine run hours are also stored in memory. Stored fault codes can be displayed on the Malfunction Indicator Light (MIL) as flash codes or read by the PG-08 Service Tool software through a CAN (Controller Area Network) communication link.

Constant battery power (12 Vdc) is supplied through the fuse block to the SECM and the main power relays. Upon detecting a key-switch ON input, the SECM will fully power up and energize the main power relays. The energized main power relays supply 12 Vdc power to the heated element of the oxygen sensors, fuel lock-off, fuel trim valve (FTV), crank sensor, cam sensor, and the ignition coils. The SECM supplies voltage to the electronic throttle actuator, oil pressure switch, fuel temperature sensor, and the coolant temperature sensor. Transducer or sensor power (+ 5 Vdc) is regulated by the SECM and supplied to the manifold temperature/air pressure (TMAP) sensor, throttle position sensor (TPS), and the accelerator pedal position sensors (APP1 & APP2). The SECM provides a transducer ground for all the sensors, and a low side driver signal controlling the fuel lock-off, MIL, and FTV.

Fuel Management

During engine cranking at startup, the SECM provides a low side driver signal to the fuel lock-off, which opens the lock-off allowing natural gas to flow to the 210DZ regulator. A stall safety shutoff feature is built into the SECM to close the lock-off in case of a stall condition. The SECM monitors three engine states:

Crank, when the crankshaft position sensor detects any engine revolutions

Stall, when the key is in the ON position but the crankshaft position sensor detects no engine revolutions

Run state, when the engine reaches pre-idle RPM.

When an operator turns on the key switch the lock-off is opened but if the operator fails to crank the engine, the SECM will close the lock-off after about 5 seconds.

To maintain proper exhaust emission levels, the SECM uses a heated exhaust gas oxygen sensor (HEGO) mounted before the catalyst, to measure exhaust gas content in the fuel system. Engine speed is monitored by the SECM through a Hall-Effect type sensor. Intake manifold air temperature and absolute pressure are monitored with a (TMAP) sensor. The HEGO voltage is converted to an air/fuel ratio value. This value is then compared to a target value in the SECM. The target value is based on optimizing catalyst efficiency for a given load and

speed. The SECM then calculates any corrections that need to be made to the air/fuel ratio.

The system operates in open loop fuel control until the engine has done a certain amount of work. This ensures that the engine and HEGO are sufficiently warmed up to stay in control. In open loop control, the FTV duty cycle is based on engine speed and load. Once the HEGO reaches operating temperature the fuel management is in closed loop control for all steady state conditions, from idle through full throttle. In closed loop mode, the FTV duty cycle is based on feedback from the HEGO sensor. The system may return to open-loop operation when engine load or engine speed vary beyond a chosen threshold.

The SECM makes any necessary corrections to the air-fuel ratio by controlling the inlet fuel pressure to the air-fuel mixer. Reducing the fuel pressure leans the air/fuel mixture and increasing the fuel pressure enriches the air-fuel mixture. Control is achieved by modulating the fuel trim valves.

Speed Management

Drive-by-wire refers to the fact that the PG-08 control system has no throttle cable from the speed input device to the throttle body. Instead, the SECM is electronically connected both to the speed request signal and the throttle body. The SECM monitors the speed input device position and controls the throttle plate by driving a DC motor connected to the throttle. The DC motor actuates the throttle plate to correspond to the torque demand from the governor position. The SECM will override the torque/speed command above a maximum engine speed and below a minimum idle speed.

The use of electronic throttle control (ETC) ensures that the engine receives only the correct amount of throttle opening for any given situation, greatly improving idle quality and drivability.

Two throttle position sensors (TPS1 and TPS2), which are integral to the drive-by-wire (DBW) throttle assembly, provide feedback for position control by monitoring the exact position of the throttle valve. See **Figure 11**.

SECM self-calibration and “cross checking” compares both signals and then checks for errors.

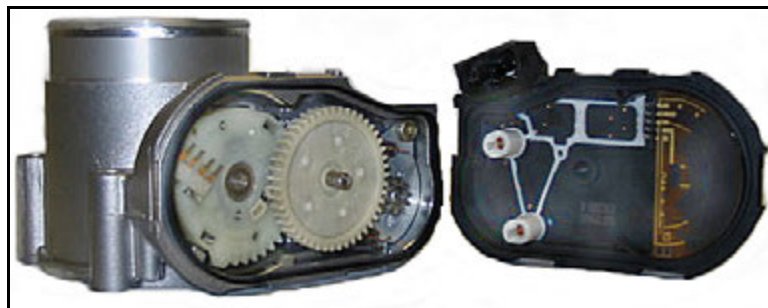

Figure 11. Throttle Position Sensor (TPS) on DV-E5 Throttle



NOTE

The DV-E5 throttle is not a serviceable assembly. If a TPS sensor fails, the assembly should be replaced.

ENGINE SPEED GOVERNING

For idle speed control, the idle speed is controlled by the SECM. Unlike a mechanical system, the idle speed is not adjustable by the end user. The idle speed is adjusted by the SECM based on engine coolant temperature. At the low engine speeds, the SECM may use spark and throttle to maintain a constant speed regardless of load.

Ignition Management

In the normal course of events, with the engine operating at the correct temperature in defined conditions, the SECM will use load and engine speed to derive the correct ignition timing. In addition to load and speed there are other circumstances under which the SECM may need to vary the ignition timing, such as start-up, and idle speed control.

SECM / Sensors

The 48-pin Small Engine Control Module (SECM) and sensors provide the computational power, algorithm logic, sensor inputs and control outputs to control the system. The SECM receives signals from the sensors, digitizes these signals, and then, through algorithms and calibration maps, computes the desired output response to effect control of fuel, spark and air to the engine. The SECM also provides a variety of other functions and features. These include system monitoring and diagnostics to aid in maintaining efficient system operation and auxiliary control.



SECM/sensor inputs and control output specifications are specific to the application, but include a selection of the following:

Analog Inputs

The 48-pin SECM is equipped with sufficient analog inputs for the following sensors.

- **Manifold Absolute Pressure (MAP)** 1bar MAP, 0 to 5 V
- **Manifold Air Temperature (MAT)**
-40°F to 266°F (-40°C to 130°C) range, 48 kohm to 85 ohm sensor range
- **Throttle Position Sensor 1&2 (TPS1 & TPS2)** 0 to 5 V
- **Foot Pedal Position 1&2 (FPP1 & FPP2)** 0 to 5 V
- **Coolant Temperature Sensor (CTS)**
-40°F to 266°F (-40°C to 130°C) range, 48K ohm to 85 ohm sensor range
- **HEGO (3)** 0 to 1 V
- **Oil Pressure (1)** 0 to 5 V
- **Auxiliary Analog Input (1)** 0 to 5 V
- **Battery Voltage (Vbatt) (1)** 8-18 V

With the exception of battery voltage, all inputs are 0-5 Vdc, ground referenced. Resolution should be 0.1% or better. Accuracy should be 2% or better.

Frequency/Position Inputs

- **Crankshaft position**

Variable reluctance (2-wire, 200 Vpp max) or 0-5 V Hall Effect with calibration selectable pull-up resistor for open collector sensors
Permits speed resolution of 0.25 rpm and crankshaft position resolution of 0.5°

- **Camshaft position**

Variable reluctance (2-wire, 200 Vpp max) or 0-5 V Hall Effect with calibration selectable pull-up resistor for open collector sensors.

Digital Inputs

- **Speed select switch**

Permits selecting four different maximum engine speeds

- **Vswitched**

Switched battery voltage

Outputs

- **FTV drivers (2, 1 used)**

10A peak, 45V max. To drive an on/off fuel trim valve with a minimum impedance of 5 ohms

Capable of continuous on-time

Drive circuit designed for minimum turn-on /turn-off delay

FTV command will be given as a PWM signal at 400 hz with a duty cycle between 10% and 90%.

- **Fuel lock-off solenoid valve**

Low side switch, 10A peak, 4A continuous 45 V max

- **Electronic Spark Timing (EST) (8)**

TTL compatible outputs

Software configured for coil-on-plug ignition system

- **Throttle control (1)**

H-Bridge, 5A peak, 2.5A continuous at 2500 Hz PWM includes current feedback for diagnostic purposes.

- **MIL (malfunction indicator lamp)**

Low side switch, sufficient to drive a 7W incandescent lamp continuously

- **Autostart/autocrank relay drive**

Low side switch, sufficient to drive a relay to control starter operation

- **CANBus**

CAN 2.0b serial communication for J1939 communications, programming and diagnostics. Requires proper termination resistance per CAN 2.0b.

Chapter 2. Specifications

Fuel System Requirements

Operating Temperature	-20 °F to 221 °F [-29 °C to 105 °C]
Long-term Storage Temperature	-40 °F to 140 °F [-40 °C to 60 °C]
Short-term Storage Temperature (Heat Soak)	≤ 257 °F [125 °C]
Natural Gas Composition Requirements	Minimum 55% methane content. Energy content from 900 to 1550 BTU/ft ³

Environmental / Electrical Specifications

Ambient Operating Temperature	-20 °F to 221 °F [-29 °C to 105 °C]
Natural Gas Fuel Temperature	-20 °F to 120 °F [-29 °C to 49 °C] (Due to the low vapor pressure of natural gas below -20 °F (-29 °C), repeated cranking to start the engine may be required)
Operating Voltage	8-16 Vdc
Over Voltage Operation	18 Vdc for less than 5 minutes 24 Vdc for less than 1 minute

210DZ Pressure Regulator Specifications

Fuel Supply Pressure	8-15 inH ₂ O (37.3–76.7 mbar)
Fuel Inlet Fitting	1 1/4" NPT
Fuel Outlet Fitting	1 1/4" NPT
Max Flow	110 lbm/hr natural gas
Fuel Outlet Pressure Setpoints	-1.0 ± 0.2 inH ₂ O @ 100-2000 cubic feet per hour natural gas (-2.49 ± 0.498 mbar) -0.25 ± 0.1 inH ₂ O @ 100-2000 cubic feet per hour natural gas (-2.49 ± 0.498 mbar)
Mounting	Regulator tower must point upwards Should not be mounted on engine

D100 Mixer Specifications

Fuel	Natural Gas
Fuel Inlet Fitting	3/4" NPT
Air Intake Flange	N/A
Mixer Mounting Flange	N/A
Reference Pressure Ports	1/4" NPT port
Fuel Inlet Adjustments	None
Idle Air Adjustment	None
Mounting	Suitable for on-engine mounting.

Electronic Throttle System Specifications

Minimum Electrical Resistance of Throttle Actuator	1.5 ohms
---	----------

SECM Specifications

Operating Temperature	-20 °F to 221 °F [-29 °C to 105 °C]
Long-term Storage Temperature	-40 °F to 140 °F [-40 °C to 60 °C]
Short-term Storage Temperature (Heat Soak)	≤ 257 °F [125 °C]
Operating Voltage	8-16 Vdc SECM microprocessor may reset at voltages below 6.3 Vdc
Operating Environment	On-engine mounting, underhood automotive Capable of withstanding spray from a pressure washer

Fuel Trim Valve (FTV) Specifications

Actuator Type	L-Series trim valve configured as a positioner
Operating Voltage	8-16 Vdc

Ignition System Specifications

Coil Type	Inductive
Coil Supply Voltage	8-16 Vdc
Minimum Open Circuit Voltage	> 30 kV
Minimum Coil Energy	35 mJ
Maximum Dwell Time	4 msec
Operating Temperature	-20 °F to 221 °F [-29 °C to 105 °C]
Long-term Storage Temperature	-40 °F to 140 °F [-40 °C to 60 °C]
Short-term Storage Temperature (Heat Soak)	≤ 257 °F [125 °C]

Chapter 3.

Recommended Maintenance

Suggested maintenance requirements for an engine equipped with an PG-08 fuel system are contained in this section. The operator should, however, develop a customized maintenance schedule using the requirements listed in this section and any other requirements listed by the engine manufacturer.

Maintenance Tests & Inspections

Test Fuel System for Leaks

- Obtain a leak check squirt bottle or pump spray bottle.
- Fill the bottle with an approved leak check solution.
- Spray a generous amount of the solution on the fuel system fuel lines and connections, starting at the storage container.
- Wait approximately 15-60 seconds, then perform a visual inspection of the fuel system. Leaks will cause the solution to bubble.
- Listen for leaks
- Smell for natural gas odor which may indicate a leak
- Repair any leaks before continuing.
- Crank the engine through several revolutions. This will energize the fuel lock-off and allow fuel to flow to the pressure regulator. Apply additional leak check solution to the regulator/ converter fuel connections and housing. Repeat leak inspection as listed above.
- Repair any fuel leaks before continuing.

Inspect Engine for Fluid Leaks

- Start the engine and allow it to reach operating temperatures.
- Turn the engine off.
- Inspect the entire engine for oil and/or coolant leaks.
- Repair as necessary before continuing.

Inspect Vacuum Lines and Fittings

- Visually inspect vacuum lines and fittings for physical damage such as brittleness, cracks and kinks. Repair/replace as required.
- Solvent or oil damage may cause vacuum lines to become soft, resulting in a collapsed line while the engine is running.
- If abnormally soft lines are detected, replace as necessary.

Inspect Electrical System

- Check for loose, dirty or damaged connectors and wires on the harness including: fuel lock-off, TMAP sensor, O2 sensors, electronic throttle, control relays, fuel trim valves, crank position sensor, and cam position sensor.
- Repair and/or replace as necessary.

Inspect Coolant Hoses

- Visually inspect coolant hoses and clamps. Remember to check the two coolant lines that connect to the pressure regulator.
- Replace any hose that shows signs of leakage, swelling, cracking, abrasion or deterioration.

Inspect Battery System

- Clean battery outer surfaces with a mixture of baking soda and water.
- Inspect battery outer surfaces for damage and replace as necessary.
- Remove battery cables and clean, repair and/or replace as necessary.

Inspect Ignition System

- Remove and inspect the spark plugs. Replace as required.
- Inspect the ignition coil for cracks and heat deterioration. Replace as required.

Replace Spark Plugs

- Using a gentle twisting motion, remove the high voltage leads from the spark plugs. Replace any damaged leads.
- Remove the spark plugs.
- Gap the new spark plugs to the proper specifications.
- Apply anti-seize compound to the spark plug threads and install.
- Re-install the high voltage leads.

**CAUTION**

Do not over tighten the spark plugs.

Testing Fuel Lock-off Operation

- Start engine.
- Locate the electrical connector for the fuel lock.
- Disconnect the electrical connector.
- The engine should run out of fuel and stop within a short period of time.

**NOTE**

The length of time the engine runs on trapped fuel vapor increases with any increase in distance between the fuel lock-off and the pressure regulator.

- Turn the ignition key switch off and re-connect the fuel lock-off connector.

Pressure Regulator Inspection

- Visually inspect the pressure regulator housing for cracks or abrasions.
- Refer to Chapter 4 if the pressure regulator requires replacement.

Fuel Trim Valve Inspection (FTV)

- Visually inspect the fuel trim valves for abrasions or cracking. Replace as necessary.
- Inspect the bore of the trim valve for obstructions and contamination. Clean or replace as necessary.

Inspect Mixer Assembly

- Inspect for blockages. Clean or replace as necessary.

Inspect for Intake Leaks

- Visually inspect the throttle body assembly and intake manifold for looseness and leaks. Repair as necessary.

Inspect Throttle Assembly

- Visually inspect the throttle assembly motor housing for coking, cracks, and missing cover-retaining clips. Repair and/or replace as necessary.

**NOTE**

Refer to Chapter 4 for procedures on removing the mixer and inspecting the throttle plate.

Checking the TMAP Sensor

- Verify that the TMAP sensor is mounted tightly into the manifold or manifold adapter with no leakage.
- If the TMAP is found to be loose, remove the TMAP retaining screw and the TMAP sensor from the manifold adapter.
- Visually inspect the TMAP O-ring seal for damage. Replace as necessary.
- Apply a thin coat of an approved silicon lubricant to the TMAP O-ring seal.
- Re-install the TMAP sensor into the manifold or manifold adapter and securely tighten the retaining screw.

Inspect Engine for Exhaust Leaks

- Start the engine and allow it to reach operating temperatures.
- Perform visual inspection of exhaust system from the engine all the way to the tailpipe. Any leaks, even after the post-catalyst oxygen sensor, can cause the sensor output to be effected (due to exhaust pulsation entraining air upstream). Repair any/all leaks found. Ensure the length from the post-catalyst sensor to tailpipe is the same as original factory.
- Ensure that wire routing for the oxygen sensors is still keeping wires away from the exhaust system. Visually inspect the oxygen sensors to detect any damage.

Maintenance Schedule

**NOTE**

The PG-08 fuel system was designed for use with natural gas fuel that contains a minimum of 55% methane with an energy content from 900 to 1550 BTU/ft³. Use of non-compliant natural gas fuel may require more frequent service intervals and will disqualify the user from warranty claims.

CHECK POINT	INTERVAL HOURS					
	Daily	Every 250 Hours or 1 month	Every 500 Hours or 3 months	Every 1000 Hours or 6 months	Every 1500 Hours or 9 months	Every 2500 Hours or 1 year
General Maintenance						
Test fuel system for leaks.	Prior to any service or maintenance activity					
Inspect engine for fluid leaks.	X					
Inspect all vacuum lines and fittings.			X			
Inspect electrical system; check for loose, dirty, or damaged wires and connections.			X			
Inspect isolation mounts on engine control module for cracks and wear; replace as necessary.			X			
Inspect all fuel fittings and hoses.				X		
Inspect speed input device travel and operation.	X					
Check for MIL lamp test at key-on. If MIL lamp remains illuminated (indicating a fault), use pedal to recover fault code(s). Repair faults.	X					
Engine Coolant						
Check coolant level.	X					
Inspect coolant hoses and fittings for leaks, cracks, swelling, or deterioration.				X		
Engine Ignition						
Inspect battery for damage and corroded cables.						X
Inspect ignition system.					X	
Replace spark plugs					X	
Fuel Lock-Off/Filter						
Replace fuel filter element.				X		
Inspect lock-off and fuel filter for leaks.				X		
Ensure lock-off stops fuel flow when engine is off.				X		

Maintenance Schedule (cont'd.)

CHECK POINT	INTERVAL HOURS					
	Daily	Every 250 Hours or 1 month	Every 500 Hours or 3 months	Every 1000 Hours or 6 months	Every 1500 Hours or 9 months	Every 2500 Hours or 1 year
Pressure Regulator						
Test regulator pressures.				X		
Inspect pressure regulator vapor hose for deposit build-up. Clean or replace as necessary.				X		
Inspect regulator assembly for fuel/coolant leaks.				X		
Fuel Trim Valve						
Inspect valve housing for wear, cracks or deterioration.				X		
Ensure valve seals in the closed position when the engine is off.				X		
Replace FTV.	When indicated by MIL					
Carburetor						
Check air filter indicator.	X					
Check for air leaks in the filter system.				X		
Inspect air/fuel valve mixer assembly for cracks, loose hoses, and fittings. Repair or replace as necessary.			X			
Check for vacuum leaks in the intake system including manifold adapter and mixer to throttle adapter.						X
Repair or replace throttle assembly.	When indicated by MIL					
Inspect air filter.			X			
Replace air filter element.				X		
Check TMAP sensor for tightness and leaks.						X
Exhaust & Emission						
Inspect engine for exhaust leaks.	X					
Replace PCV valve and breather element.						X
Replace HEGO sensors						X

Chapter 4.

Installation Procedures

**WARNING—PROPER USE**

- Natural gas is highly flammable. To prevent personal injury, keep fire and flammable materials away from the lift truck when work is done on the fuel system.
- Gas vapor may reduce oxygen available for breathing, cause headache, nausea, dizziness and unconsciousness and lead to injury or death. Always operate equipment in a well ventilated area.

**CAUTION**

The regulator and mixer are part of a certified system complying with EPA and CARB 2008 requirements. Only trained, certified technicians should perform disassembly, service or replacement of the regulator or mixer.

Removal and Installation of 210DZ Regulator

**CAUTION**

The regulator and mixer are part of a certified system complying with EPA and CARB 2008 requirements. Only trained, certified technicians should perform disassembly, service or replacement of the regulator or mixer.

Refer to the installation instructions provided by the engine packager for removal and reinstallation of the 210DZ regulator.

**NOTE**

Regulator tower must be in vertical position for proper installation.



Figure 15. 210DZ Regulator

Removal and Installation of D100 Mixer



CAUTION

The regulator and mixer are part of a certified system complying with EPA and CARB 2008 requirements. Only trained, certified technicians should perform disassembly, service or replacement of the regulator or mixer.

Follow the procedures below for removal and reinstallation of the D100 mixer.

D100 Mixer Removal Steps

Refer to **Figure 16**.

1. Close fuel supply line to the engine.
2. Purge the system of fuel by starting the engine and running until all trapped fuel in the system is exhausted and the engine shuts down.
3. Key switch in "OFF" position.
4. Remove the air cleaner.
5. Remove the vacuum line.
6. Remove fuel line (2) from the trim valve inlet.
7. Disconnect the wires leading to the electronic throttle body by pinching the lock tabs on either side of the wiring harness connector. (See **Figure 17** for location of connector.)
8. Loosen the lower hose clamp on the hose (3) between the mixer (4) and the throttle body (5).
9. Gently wiggle and pull to separate mixer/adaptor/hose assembly from the throttle body.
10. Remove the trim valve (8) from the mixer body.

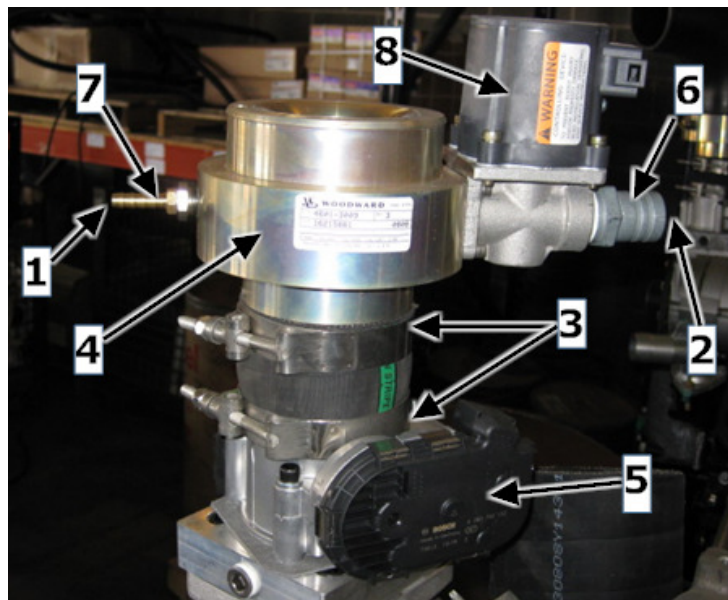

Figure 16. D100 Mixer Installed on Engine

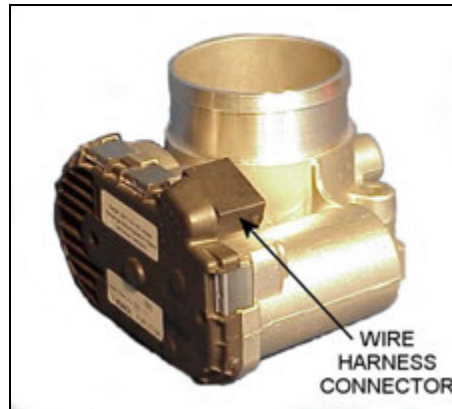

Figure 17. Wire Harness Connector on Throttle Body

D100 Mixer Installation Steps

Refer to **Figure 16**.



NOTE

Replace the hose between the mixer adapter and the throttle body if it was damaged during removal.

1. Install the trim valve (8) onto the mixer (4).
2. Place a hose clamp (3) onto the hose that is on top of the throttle body (5) and insert the barbed end of the mixer (4) into the hose. Tighten the hose clamp to 30 lbf-in (3.39 N-m).
3. Install the fuel line (2) to the trim valve inlet fitting (6).
4. Install the vacuum line (1) to the mixer.
5. Install the air cleaner hose.

Chapter 5. Tests and Adjustments



WARNING—PROPER USE

- Natural gas is highly flammable. To prevent personal injury, keep fire and flammable materials away from the lift truck when work is done on the fuel system.
- Gas vapor may reduce oxygen available for breathing, cause headache, nausea, dizziness and unconsciousness, and lead to injury or death. Always operate equipment in a well ventilated area.



CAUTION

The regulator and mixer are part of a certified system complying with EPA and CARB 2008 requirements. Only trained, certified technicians should perform disassembly, service or replacement of the regulator or mixer.

210DZ Regulator Service Testing

To check the 210DZ regulator operation, the following hardware is required:

1. Shop air pressure regulator adjusted to 0.5 psi
2. Shop air hose fitting (1/4" NPT to air hose)
3. Air hose
4. Test gauge fitting (3/4" NPT x 1/4" hose barb)
5. Vacuum hose or vinyl tubing
6. 0-15" WC Magnehelic gauge (inches of water column)



Figure 19. Regulator Pressure Test Connections

Regulator Pressure Test Procedure

Refer to **Figure 19**.

1. Field fabricate a fitting for the outlet of the regulator that will allow pressure measurement. It needs to prohibit gas flow, with the exception of a tiny 5/64" orifice. (This can be drilled anywhere in the test fitting)
2. Attach a Magnehelic gauge to the outlet of the Maxitrol regulator.
3. Connect a compressed air line (shop air 0.5 psi) to the natural gas fuel inlet of the 210DZ regulator.
4. The static pressure should read between 0.15-0.35 inH₂O on the Magnehelic gauge.
5. If the pressure reading begins to *increase*, a leak is most likely present at the valve seat, either the valve or the valve itself. If a leak is present the regulator should be replaced.
6. If the test is successful, reinstall per engine packager instructions.



The 210DZ primary stage pressure can also be tested at idle on a running engine. The 210DZ outlet pressure should be between 0.15-0.35 inH₂O at 900 rpm, idle.

**WARNING**

- Gas will be escaping from the test fitting in the test described above.
- Natural gas is highly flammable. To prevent personal injury, keep fire and flammable materials away from the lift truck when work is done on the fuel system.
- Gas vapor may reduce oxygen available for breathing, cause headache, nausea, dizziness and unconsciousness and lead to injury or death. Always operate equipment in a well ventilated area.

Connection of PG-08 Service Tool

To use the Service Tool, a USB (Universal Serial Bus) to CAN (Controller Area Network) communication adapter by KVaser will be required along with a Crypt Token (**Figure 21**). The Crypt Token acts as a security key allowing the laptop to retrieve the necessary data from the SECM.

1. Install the Crypt Token in an available USB port in the computer (**Figure 22**).
2. With the ignition key in the OFF position, connect the KVaser communication cable from a second USB port on the computer to the CAN communications cable on the engine. *If your laptop computer does not have a second USB port an appropriate USB hub will need to be used.*
3. Connect a timing light to the engine.
4. Turn the ignition key to the ON position (**Do Not Start the Engine**).
5. Launch the MotoView program on your computer and open the Service Tool display (**Figure 23**).



Figure 21. KVaser Communication Adapter



Figure 22. Crypt Token installed on Laptop



Figure 23. Opening the Service Tool Display

Chapter 6. Basic Troubleshooting

Preliminary Checks

PG-08 systems are equipped with built-in fault diagnostics. Detected system faults can be displayed by the Malfunction Indicator Lamp (MIL) and are covered in Chapter 7, Advanced Diagnostics. However, items such as fuel level, plugged fuel lines, clogged fuel filters, and malfunctioning pressure regulators may not set a fault code and usually can be corrected with the basic troubleshooting steps described on the following pages.

If engine problems are encountered with your PG-08 system, perform the checks in this section before referring to Advanced Diagnostics.

NOTE: Locating a problem in a natural gas engine is done exactly the same as with a gasoline engine. Consider all parts of the ignition and mechanical systems as well as the fuel system.

BEFORE STARTING . . .

1. Determine that the SECM and MIL light are operating. Verify operation by keying on engine and checking for flash of MIL light.

When the ignition key is turned on, the MIL will illuminate and remain on until the engine is started. Once the engine is started, the MIL lamp will go out unless one or more fault conditions are present. If a detected fault condition exists, the fault or faults will be stored in the memory of the small engine control module (SECM). Once an active fault occurs the MIL will illuminate and remain ON. This signals the operator that a fault has been detected by the SECM.

2. Determine that there are no diagnostic codes stored, or there is a diagnostic code but no MIL light.

VISUAL/PHYSICALCHECK

Several of the procedures call for a "Careful Visual/Physical Check" which should include:

- SECM grounds for being clean and tight
- Vacuum hoses for splits, kinks, and proper connection.
- Air leaks at throttle body mounting and intake manifold
- Exhaust system leaks
- Ignition wires for cracking, hardness, proper routing, and carbon tracking
- Wiring for pinches and cuts

Also check:

- Connections to determine that none are loose, cracked, or missing
- Fuel pressure is sufficient
- Fuel is not leaking
- Battery voltage is greater than 11.5 volts

**NOTE**

The Visual/Physical check is very important, as it can often correct a problem without further troubleshooting and save valuable time.

Basic Troubleshooting

Intermittents

An intermittent fault is the most difficult to troubleshoot since the MIL flashes on at random, causing uncertainty in the number of flashes or the conditions present at the time of the fault. Also, the problem may or may not fully turn "ON" the MIL light or store a code.

Therefore, the fault must be present or able to be recreated in order to locate the problem. If a fault is intermittent, use of diagnostic code charts may result in the unnecessary replacement of good components.

CORRECTIVE ACTION
<p>Most intermittent problems are caused by faulty electrical connections or wiring. Perform careful visual/physical check for:</p> <ul style="list-style-type: none"> • Poor mating of the connector halves or terminal not fully seated in the connector body (backed out) • Improperly formed or damaged terminal. All connector terminals in problem circuit should be carefully reformed or replaced to insure proper contact tension • Loose connections or broken wires • Poor terminal to wire connection crimp
<p>If a visual/physical check does not find the cause of the problem, perform the following:</p> <ol style="list-style-type: none"> (1) Run the engine with a voltmeter or "Service" tool connected to a suspected circuit. Check if circuit is active and signal is reasonable. (2) Using the "Service" tool, monitor the input signal to the SECM to help detect intermittent conditions. (3) An abnormal voltage, or "Service" reading, when the problem occurs, indicates the problem may be in that circuit. (4) If the wiring and connectors check OK, and a diagnostic code was stored for a circuit having a sensor, check sensor.
<p>An intermittent MIL light with no stored diagnostic code may be caused by:</p> <ul style="list-style-type: none"> • Ignition coil shortage to ground and arcing at spark plug wires or plugs • MIL light wire to ECM shorted to ground • SECM grounds (refer to SECM wiring diagrams).
<p>Check for improper installation of electrical options such as lights, 2-way radios, accessories, etc.</p>
<p>EST wires should be routed away from spark plug wires, coils and generator. Wires from SECM to ignition should have a good connection.</p>

Basic Troubleshooting (cont'd.)

Surges and/or Stumbles

Engine power varies under steady throttle. Sounds like the engine speeds up and slows down with no change in the speed command.

PRELIMINARY CHECKS

Perform the visual checks as described at start of "Basic Troubleshooting" chapter. Be sure operator understands engine operation as explained in the operator manual.

PROBABLE CAUSE	CORRECTIVE ACTION
Oxygen sensor malfunction	The fuel management should maintain a stoichiometric air-fuel ratio under all steady state operating conditions following engine warmup. Failure of the Pre-catalyst O ₂ sensor should cause an O ₂ sensor fault that can be diagnosed with the MIL lamp or Service Tool.
Fuel system malfunction	NOTE: To determine if the condition is caused by a rich or lean system, the engine should be run at the speed of the complaint. Monitoring pre-catalyst O ₂ adapts* or trim valve duty cycle will help identify problem. Check fuel supply while condition exists. Check in-line fuel filter. Replace if dirty or plugged. Check fuel pressure.
Ignition system malfunction	Check for proper ignition voltage output using spark tester. Check spark plugs. <ul style="list-style-type: none"> • Remove spark plugs, check for wet plugs, cracks, wear, improper gap, burned electrodes, or heavy deposits. • Repair or replace as necessary. • Check condition of distributor cap, rotor and spark plug wires (where applicable). • Check ignition timing.
Component malfunction	Check vacuum lines for kinks or leaks. Check alternator output voltage. Repair if less than 9 or more than 16 volts.
Exhaust backpressure	Check condition of exhaust system. Check backpressure before catalyst. It should be less than 3.5 psig (24.13 kPa).

(*) Refer to **Table 1** for description of gaseous O₂ adapts.

Related MIL Faults:

Pre-catalyst O₂ sensor errors / O₂ control errors

Trim valve DC faults / EST faults / ETC faults / L-Series fault

Basic Troubleshooting (cont'd.)

Engine Cranking but Will Not Start / Difficult to Start

Engine cranks OK, but does not start for a long time. Does eventually run, or may start but immediately dies.

PRELIMINARY CHECKS
Perform the visual checks as described at start of “ Basic Troubleshooting” chapter. Be sure operator is using correct method to start engine as explained in operator’s manual. Use “clear flood” mode during cranking by fully depressing the pedal and cranking the engine. If engine does not start, continue troubleshooting.

PROBABLE CAUSE	CORRECTIVE ACTION
Plugged fuel line	Remove obstruction from the fuel line. <ul style="list-style-type: none"> • Using caution, disconnect the fuel line (some natural gas may escape). • Clear obstruction with compressed air. • Re-connect fuel line. • Leak test.
Clogged fuel filter	Repair/replace as required. <i>See Chapter 3 Fuel Filter replacement.</i>
Faulty vapor connection between the pressure regulator and the mixer	Check connection <ul style="list-style-type: none"> • Verify no holes in hose. • Clamps must be tight. • Look for kinked, pinched and/or collapsed hose.
Fuel lock-off malfunction	Repair/replace fuel lock-off. <i>See Chapter 3 Fuel Lock-off.</i>
Pressure regulator malfunction	Test regulator operation and pressure. <i>See Chapter 5 Tests and Adjustments.</i>
Incorrect air/fuel or ignition/spark control	<i>See Chapter 7 Advanced Diagnostics.</i>
No crankshaft position sensor signal	Verify the crankshaft position signal is present <i>See Chapter 7 Advanced Diagnostics.</i>

(continued on next page)

Basic Troubleshooting (cont'd.)

Engine Cranking but Will Not Start / Difficult to Start (cont'd.)

PROBABLE CAUSE	CORRECTIVE ACTION
SECM / control system malfunction	<p>Check Coolant Temperature Sensor using the Service Tool; compare coolant temperature with ambient temperature on cold engine.</p> <p>If coolant temperature reading is 5° greater than or less than ambient air temperature on a cold engine, check resistance in coolant sensor circuit or sensor itself. Compare CTS resistance value to "Diagnostic Aids" chart at end of this section.</p> <p>Verify that there is no code for ETC spring check fault.</p> <p>Check for 0% APP during cranking.</p> <p>Cycle key ON and OFF and listen for throttle check (movement) on key OFF.</p> <p>Check for oil pressure switch faults.</p> <p>Check for sensor "sticking" faults.</p> <p>Check TPS for stuck binding or a high TPS voltage with the throttle closed.</p>
Fuel system malfunction	<p>Check fuel lock off: actuator should turn "ON" for 2 seconds when ignition is turned "ON".</p> <p>Check fuel pressure.</p> <p>Check for contaminated fuel.</p> <p>Check lock off fuses (visually inspect).</p> <p>Check FTV system for proper operation.</p>
Ignition system malfunction	<p>Check for proper ignition voltage output with spark tester.</p> <p>Check spark plugs. Remove spark plugs, check for wet plugs, cracks, wear, improper gap, burned electrodes, or heavy deposits. Repair or replace as necessary.</p> <p>Check for:</p> <ul style="list-style-type: none"> • Bare or shorted wires • Loose ignition coil ground • Pickup coil resistance and connections <p>(*) Where present</p>

Related MIL Faults:

ETC spring check / ETC faults / EST faults / TPS conflict
 APP faults / Encoder error / MAP faults / Oil pressure faults

Basic Troubleshooting (cont'd.)

Lack of Power, Slow to Respond / Poor High Speed Performance / Hesitation During Acceleration

Engine delivers less than expected power. Little or no increase in speed when speed increase is commanded. Momentary lack of response as an increase in speed is commanded. Can occur at all engine speeds. Usually most severe when first applying a load to the engine. May cause engine to stall.

PRELIMINARY CHECKS

Perform the visual checks as described at start of "Basic Troubleshooting" chapter.
Operate engine; verify problem exists.
Remove air filter and check for dirt or other means of plugging. Replace if needed.

PROBABLE CAUSE	CORRECTIVE ACTION
Fuel system malfunction	Check for restricted fuel filter. Check fuel supply. Check for contaminated fuel. Check for clogged fuel filter and repair or replace as required. <i>See Chapter 3 Fuel Filter replacement</i> Check for plugged fuel line and remove any obstruction from the fuel line: <ul style="list-style-type: none"> • Using caution, disconnect the fuel line (some natural gas may escape). • Clear obstruction with compressed air. • Re-connect fuel line. Check for faulty vapor connection between pressure regulator and mixer: <ul style="list-style-type: none"> • Verify that there are no holes in hose. • Observe that clamps are tight. • Look for kinked, pinched and/or collapsed hose. Monitor pre-catalyst O ₂ with Service Tool. Check for proper pressure regulator operation. <i>See Chapter 5 Test and Adjustments.</i> Check for proper air/fuel mixer operation.
Ignition system malfunction	Check spark advance for excessive retarded ignition timing. Use Service Tool. Check secondary voltage using an oscilloscope or a spark tester to check for a weak coil. Check spark plug condition. Check poor spark plug primary and secondary wire condition.

(continued on next page)

Lack of Power, Slow to Respond / Poor High Speed Performance Hesitation During Acceleration (cont'd.)

PROBABLE CAUSE	CORRECTIVE ACTION
Component malfunction	<p>Check SECM grounds for cleanliness and secure connection. See SECM wiring diagrams.</p> <p>Check alternator output voltage. Repair if less than 9 volts or more than 16 volts.</p> <p>Check for clogged air filter and clean or replace as required.</p> <p>Check exhaust system for possible restriction. Refer to Chart T-1 on later pages.</p> <p>Inspect exhaust system for damaged or collapsed pipes.</p> <ul style="list-style-type: none"> • Inspect muffler for heat distress or possible internal failure. • Check for possible plugged catalytic converter by comparing exhaust system backpressure on each side at engine. Check backpressure by removing Pre-catalyst O2 sensor and measuring backpressure with a gauge.
Engine mechanical	<p><i>See Engine Manufacturer's Service Manual.</i></p> <p>Check engine valve timing and compression</p> <p>Check engine for correct or worn camshaft.</p>

Related MIL Faults:

EST faults
 ETC faults
 ETC spring check
 TPS faults
 APP faults
 Encoder error
 Delayed Shutdown faults

Basic Troubleshooting (cont'd.)

Detonation / Spark Knock

A mild to severe ping, usually worse under acceleration. The engine makes sharp metallic knocks that change with throttle opening (similar to the sound of hail striking a metal roof).

PRELIMINARY CHECKS
Perform the visual checks as described at start of "Basic Troubleshooting" chapter.

PROBABLE CAUSE	CORRECTIVE ACTION
Fuel system malfunction	Check fuel pressure. To determine if the condition is caused by a rich or lean system, the engine should be run at the speed of the complaint. Monitoring with the Service Tool will help identify problem.
Cooling system malfunction	Check for obvious overheating problems: <ul style="list-style-type: none"> • Low engine coolant • Loose water pump belt • Restricted air flow to radiator, or restricted water flow through radiator • Inoperative electric cooling fan • Correct coolant solution should be a mix of anti-freeze coolant (or equivalent) and water • High coolant temperature
Ignition system malfunction	Check ignition timing. Check spark module wiring.
Exhaust system malfunction	Check exhaust backpressure. Check for debris clogging the catalyst. Check that pre-catalyst O2 sensor is functioning.
Engine mechanical	Check for excessive oil in the combustion chamber and/or blow by from excessive PCV flow. Check combustion chambers for excessive carbon build up. Check combustion chamber pressure by performing a compression test. Check for incorrect basic engine parts such as cam, heads, pistons, etc.

Related MIL Faults:

EST faults

Encoder error

High coolant temperature faults

Basic Troubleshooting (cont'd.)

Backfire

Fuel ignites in intake manifold or in exhaust system, making loud popping noise.

PRELIMINARY CHECKS	
Perform the visual checks as described at start of " Basic Troubleshooting" chapter. Simulate condition by reviewing operation procedure practiced by engine operator.	

PROBABLE CAUSE	CORRECTIVE ACTION
Fuel system malfunction	Perform fuel system diagnosis check: <ul style="list-style-type: none"> • Check for fuel leaks • Check for MIL faults • Check for damaged components
Ignition system malfunction	Check proper ignition coil output voltage with spark tester. Check spark plugs. Remove spark plugs, check for wet plugs, cracks, wear, improper gap, burned electrodes, or heavy deposits. Repair or replace as necessary. Check spark plug wires for crossfire and proper routing. Check ignition timing.
Engine mechanical	Check compression: look for sticking or leaking valves. Check intake and exhaust manifold for casting flash and gasket misalignment.

Related MIL Faults: EST faults / ETC faults / Encoder error
Pre-catalyst O2 sensor faults

Dieseling, Run-on

Engine continues to run after key is turned "OFF," but runs very roughly. If engine runs smoothly, check ignition switch and adjustment.

PRELIMINARY CHECKS	
Perform the visual checks as described at start of " Basic Troubleshooting" chapter.	

PROBABLE CAUSE	CORRECTIVE ACTION
Fuel system malfunction	Check for fuel leaks.
Ignition switching	Make sure power to system is shut off when key is in OFF position.
Fuel lock off valve	Make sure lock off valve is closing properly.
Ignition system malfunction	Check spark advance at idle.

Related MIL Faults: EST faults / ETC faults / Pre-catalyst O2 sensor faults

Basic Troubleshooting (cont'd.)

Rough, Unstable, Incorrect Idle, or Stalling

Engine cranks OK, but does not start for a long time. Does eventually run, or may start but immediately dies.

PRELIMINARY CHECKS

Perform the visual checks as described at start of "Basic Troubleshooting" chapter.
Check for vacuum leaks.
Check that SECM grounds are clean and tight. See SECM wiring diagram.

PROBABLE CAUSE	CORRECTIVE ACTION
Fuel system malfunction	<p>Monitor oxygen feedback to help identify the cause of the problem. If the system is running lean or if the system is running rich evaluate further i.e. trim valve duty cycle.</p> <p>Check for incorrect minimum idle speed that may be caused by foreign material accumulation in the throttle bore, on the throttle valve, or on the throttle shaft.</p> <p>The pre-catalyst oxygen (O₂) sensor should respond quickly to different throttle positions. If it does not, then check the pre-catalyst O₂ sensor for contamination. If the pre-catalyst O₂ sensor is aged or contaminated, the SECM will not deliver correct amount of fuel, resulting in a performance problem.</p>
Ignition system malfunction	Check ignition system; wires, plugs, etc.
Natural gas pressure regulator malfunction	Test regulator operation and pressure. <i>See Chapter 5 Tests and Adjustments</i>
Air/fuel mixer malfunction	Check mixer.
Component malfunction	<p>Check throttle for sticking or binding.</p> <p>Check PCV valve for proper operation by placing finger over inlet hole in valve end several times. Valve should snap back. If not, replace valve.</p> <p>Check alternator output voltage. Repair if less than 9 or more than 16 volts.</p>
Engine mechanical	Perform a cylinder compression check. <i>See Engine Manufacturer's Service Manual.</i>

(continued on next page)

Basic Troubleshooting (cont'd.)

Rough, Unstable, Incorrect Idle, or Stalling (cont'd.)

PROBABLE CAUSE	CORRECTIVE ACTION
Clogged fuel filter	Repair/replace as required <i>See Chapter 3 Fuel Filter Replacement</i>
Plugged fuel line	Remove obstruction from the fuel line. <ul style="list-style-type: none"> • Using caution, disconnect the fuel line (some natural gas may escape). • Clear obstruction with compressed air. • Re-connect fuel line.
Fuel lock-off malfunction	Repair/replace fuel lock-off. <i>See Chapter 3 Fuel Lock-Off.</i>
Faulty vapor connection between the pressure regulator and the mixer	Check connection. <ul style="list-style-type: none"> • Verify no holes in hose. • Clamps must be tight. • Look for kinked, pinched and/or collapsed hose.
Vacuum leak	Check for vacuum leaks . . . <ul style="list-style-type: none"> • Between mixer and throttle body • Between throttle body and intake manifold • Between intake manifold and cylinder head

Related MIL Faults:

EST faults

ETC Sticking fault

Pre-catalyst adapts error

Basic Troubleshooting (cont'd.)

Cuts Out, Misses

Steady pulsation or jerking that follows engine speed, usually more pronounced as engine load increases, sometimes above 1500 rpm. The exhaust has a steady spitting sound at idle or low speed.

PRELIMINARY CHECKS
Perform the visual checks as described at start of "Basic Troubleshooting" chapter.

PROBABLE CAUSE	CORRECTIVE ACTION
Fuel system malfunction	<p>Check fuel system specifically for plugged fuel filter, low pressure.</p> <p>Check for contaminated fuel.</p> <p>Check lock off intermittent connection.</p> <p>Check trim valve operation.</p>
Ignition system malfunction	<p>Check for spark on the suspected cylinder(s) using a shop oscilloscope or spark tester or equivalent. If no spark, check for intermittent operation or miss. If there is a spark, remove spark plug(s) in these cylinders and check for cracks, wear, improper gap, burned electrodes, heavy deposits.</p> <p>Check spark plug wires by connecting ohmmeter to ends of each wire in question. If meter reads over 30,000 ohms, replace wire(s).</p> <p>Visually inspect wires for moisture, dust, cracks, burns, etc. Spray plug wires with fine water mist to check for shorts.</p> <p>Check engine ground wire for looseness or corrosion.</p>
Component malfunction	<p>Check for electromagnetic interference (EMI). A missing condition can be caused by EMI on the reference circuit. EMI can usually be detected by monitoring engine rpm with Service Tool. A sudden increase in rpm with little change in actual engine rpm indicates EMI is present. If problem exists, check routing of secondary wires and check ignition ground circuit.</p> <p>Check intake and exhaust manifolds for casting flash or gasket leaks.</p>
Engine mechanical	<p>Perform compression check on questionable cylinders. If compression is low, repair as necessary.</p> <p>Check base engine. Remove rocker covers and check for bent pushrods, worn rocker arms, broken valve springs, worn camshaft lobes, and valve timing. Repair as necessary.</p>

Related MIL Faults:

EST faults

ETC Sticking fault

Basic Troubleshooting (cont'd.)

Poor Fuel Economy / Excessive Fuel Consumption Natural Gas Exhaust Smell

Fuel economy, as measured during normal operation, is noticeably lower than expected. Also, economy is noticeably lower than what it has been in the past.

PRELIMINARY CHECKS
Perform the visual checks as described at start of "Basic Troubleshooting" chapter. Verify operator complaint: identify operating conditions. Check typical operating conditions: Is acceleration too much, too often? Check air cleaner element (filter) for being dirty or plugged. Visually (physically) check vacuum hoses for splits, kinks, and proper connections.

PROBABLE CAUSE	CORRECTIVE ACTION
Fuel system malfunction	Check for faulty pressure regulator. Check that trim valve duty cycle is < 15%. Check for too high natural gas pressure at mixer (> 1" positive pressure). Monitor Pre-catalyst O2 sensor with Service Tool.
Cooling system malfunction	Check engine coolant level. Check engine thermostat for faulty part (always open) or for wrong heat range.
Ignition system malfunction	Check ignition timing. Check for weak ignition and/or spark control. Check spark plugs. Remove spark plugs and check for wet plugs, cracks, wear, improper gap, burned electrodes, or heavy deposits. Repair or replace as necessary.
Component malfunction	Check for exhaust system restriction or leaks. Check induction system and crankcase for air leaks. Check for clogged air filter; clean or replace as required. Check FTV for housing cracks or obstructions; repair or replace as required. Check for vacuum leak. Check system vacuum hoses from regulator to FTV and mixer. Repair or replace as required.
Air/fuel mixer malfunction	Check mixer.
Pressure regulator malfunction / fuel pressure too high	Test regulator operation and pressure. <i>See Chapter 5 Tests and Adjustments.</i>
Engine mechanical	Check compression. <i>Refer to Engine Manufacturer's Service Manual.</i>

Related MIL Faults:

Pre-catalyst O2 sensor faults / Low side driver / Trim valve duty cycle
 EST faults / Fuel adapt faults / Low coolant temperature

Basic Troubleshooting (cont'd.)

High Idle Speed

Engine idles above the range of 750-1000 rpm.

PRELIMINARY CHECKS
Perform the visual checks as described at start of "Basic Troubleshooting" chapter.

PROBABLE CAUSE	CORRECTIVE ACTION
Incorrect idle speed control	Check all hoses and gaskets for cracking, kinks, or leaks. Verify that there are no vacuum leaks. <i>See Chapter 7 Advanced Diagnostics & Chapter 5 Tests and Adjustments</i>
Throttle sticking	Replace throttle. <i>See Fault Code 461: ETC_Sticking</i>
Speed input device sticking or incorrect speed signal	Check APP function with Service Tool. Verify smooth change of APP reading with potentiometer movement. <i>See Chapter 7 Advanced Diagnostics.</i>
Engine mechanical	Check for vacuum hose leak. Check for PCV malfunction. Check for defective intake gasket.

Related MIL Faults:

ETC Sticking fault
Idle adapt out of range
MAP Sticking fault
MAP high value

Basic Troubleshooting (cont'd.)

Excessive Exhaust Emissions or Odors

Engine has high CO emissions.

NOTE: Excessive odors do not necessarily indicate excessive emissions.

PRELIMINARY CHECKS
<p>Verify that no stored codes exist.</p> <p>If emission test shows excessive CO and HC, check items that cause engine to run rich.</p> <p>If emission test shows excessive NOx, check items that cause engine to run lean or too hot.</p>

PROBABLE CAUSE	CORRECTIVE ACTION
Cooling system malfunction	<p>If the Service Tool indicates a very high coolant temperature and the system is running <i>lean</i>:</p> <ul style="list-style-type: none"> • Check engine coolant level. • Check engine thermostat for faulty part (always open) or for wrong heat range. • Check fan operation
Fuel system malfunction	<p>If the system is running <i>rich</i>, refer to “Diagnostic Aids” chart on the next page.</p> <p>If the system is running <i>lean</i> refer to “Diagnostic Aids” chart on the next page.</p> <p>Check for properly installed fuel system components.</p> <p>Check fuel pressure.</p>
Ignition system malfunction	<p>Check ignition timing.</p> <p>Check spark plugs, plug wires, and ignition components.</p>
Component malfunction	<p>Check for vacuum leaks.</p> <p>Check for contamination in catalytic converter.</p> <p>Check for carbon build-up. Remove carbon with quality engine cleaner. Follow instructions on label.</p> <p>Check for plugged PCV valve.</p> <p>Check for stuck or blocked PCV hose.</p> <p>Check for fuel in the crankcase.</p>

Related MIL Faults:

Low side driver
 Fuel adapt faults
 EST faults

Diagnostic Aids for Rich / Lean Operation

SERVICE TOOL ITEM	RICH	LEAN
Pre-catalyst O2 A/ D counts	Consistently > 250	Consistently < 170
Pre-catalyst O2 sensor switching between high and low	Always high ADC	Always low ADC
Trim valve duty cycle	> 90%	< 10%
Malfunction codes	<ul style="list-style-type: none"> • Pre-catalyst O2 sensor failed rich • Pre-catalyst O2 sensor high • Fuel adapts 	<ul style="list-style-type: none"> • Pre-catalyst O2 sensor failed lean • Pre-catalyst O2 sensor low • Fuel adapts
Closed loop operation	Stuck in open loop	Stuck in open loop

RICH OPERATION

Gaseous fuel (Trim valve duty cycle > 90%)

- Check trim valve for proper operation, replace as necessary
- Check regulator out pressure, replace if out of spec
- Check natural gas composition.

LEAN OPERATION

Gaseous fuel (trim valve duty cycle < 10%)

- Check for vacuum leaks, replace hoses, o-rings, and gaskets as necessary
- Check balance line for blockage, replace as necessary
- Check vapor hose for restrictions, replace as necessary
- Check trim valve for proper operation, replace as necessary
- Check regulator out pressure, replace if out of spec
- Check natural gas composition.

Chart T-1 Restricted Exhaust System Check

Proper diagnosis for a restricted exhaust system is essential before replacement of any components. The following procedures may be used for diagnosis, depending upon engine or tool used.

CHECK AT PRE-CATALYST OXYGEN (O₂) SENSOR

1. Carefully remove pre-catalyst oxygen (O₂) sensor.
2. Install exhaust backpressure tester or equivalent in place of O₂ sensor using Snap-On P/N EEVPV311A kit and YA8661 adapter or Mac tool. See **Figure 26**.
3. After completing test described below, be sure to coat threads of O₂ sensor with anti-seize compound prior to re-installation.

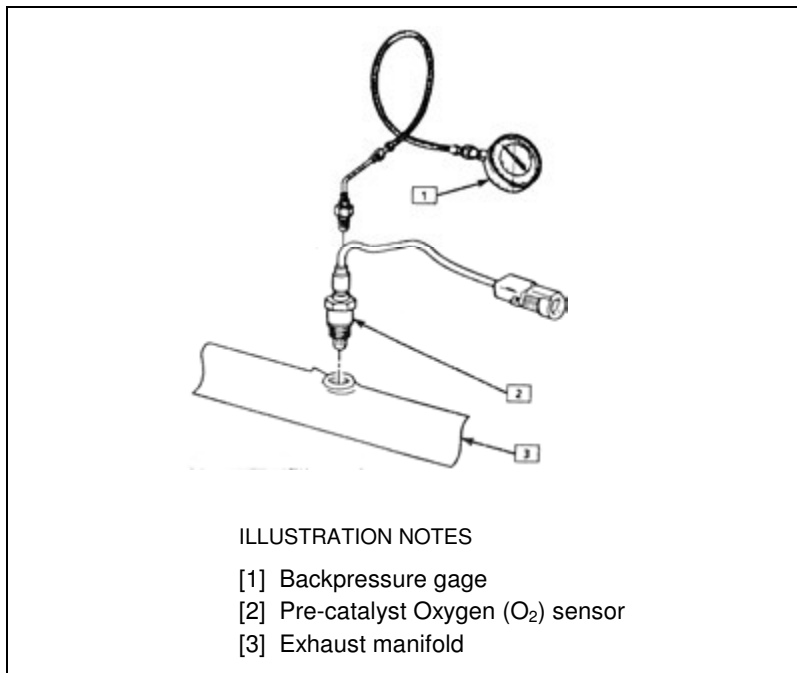

Courtesy of GM 1991 Service Manual for Chevrolet Camaro © 1990

Figure 26. Installing Exhaust Backpressure Tester

DIAGNOSIS:

1. With the engine idling at normal operating temperature, observe the exhaust system backpressure reading on the gage. Reading should not exceed 1.25 psig (8.61 kPa).
2. Increase engine speed to 2000 RPM and observe gage. Reading should not exceed 3 psig (20.68 kPa).
3. If the backpressure at either speed exceeds specification, a restricted exhaust system is indicated.
4. Inspect the entire exhaust system for a collapsed pipe, heat distress, or possible internal damage, split welds, or cracked pipe.
5. If there are no obvious reasons for the excessive backpressure, the catalytic converter is restricted and should be replaced using current recommended procedures.

Chapter 7.

Advanced Diagnostics

PG-08 systems are equipped with built-in fault diagnostics. Detected system faults can be displayed by the Malfunction Indicator Lamp (MIL) as Diagnostic Fault Codes (DFC) or flash codes, and viewed in detail with the use of the Service Tool software. When the ignition key is turned on, the MIL will illuminate and remain on until the engine is started. Once the engine is started, the MIL lamp will go out unless one or more fault conditions are present. If a detected fault condition exists, the fault or faults will be stored in the memory of the small engine control module (SECM). Once an active fault occurs the MIL will illuminate and remain ON. This signals the operator that a fault has been detected by the SECM.

Reading Diagnostic Fault Codes

All PG-08 fault codes are three-digit codes. When the fault codes are retrieved (displayed) the MIL will flash for each digit with a short pause (0.5 seconds) between digits and a long pause (1.2 seconds) between fault codes. A code 12 is displayed at the end of the code list.

EXAMPLE: A code 461 (ETCSticking) has been detected and the engine has shut down and the MIL has remained **ON**. When the codes are displayed the MIL will flash four times (**4**), pause, then flash six times (**6**), pause, then flash one time (**1**) This identifies a four sixty one (**461**), which is the ETCSticking fault. If any additional faults were stored, the SECM would again have a long pause, then display the next fault by flashing each digit. Since no other faults were stored there will be a long pause then one flash (**1**), pause, then two flashes (**2**). This identifies a twelve, signifying the end of the fault list. This list will then repeat.

Displaying and Clearing Fault Codes (DFC) from SECM Memory

Retrieving and clearing fault codes without the use of the PG-08 service tool is possible by using a device to cycle the speed input through the SECM's potentiometer connection. Accomplishing code retrieval and clearing requires a special device. This device has the capability of cycling the potentiometer input at a specific frequency through a specific voltage range that will initiate both code flashing (on MIL) and code clearing. Contact Buck's Engines for information and availability of such a device.

**CAUTION**

Once the fault list is cleared it cannot be restored.

Fault Action Descriptions

Each fault detected by the SECM is stored in memory (FIFO) and has a specific action or result that takes place. Listed below are the descriptions of each fault action.

Engine Shutdown: The most severe action is an Engine Shutdown. The MIL will light and the engine will immediately shut down, stopping spark and closing the fuel lock-off solenoid valve.

Delayed Engine Shutdown: Some faults, such as low oil pressure, will cause the MIL to illuminate for 30 seconds and then shut down the engine.

Cut Fuel: Fuel flow will be turned off.

Cut Throttle: The throttle moves to its default position. The engine will run at idle but will not accelerate.

Turn on MIL: The MIL will light by an active low signal provided by the SECM, indicating a fault condition. May illuminate with no other action or may be combined with other actions, depending on which fault is active.

Soft Rev Limit / Medium Rev Limit / Hard Rev Limit: System will follow various sequences to bring engine speed back to acceptable levels.

Level4 Power Limit / Level3 Power Limit / Level2 Power Limit / Level1 Power Limit: The maximum engine power output will be limited to one of four possible levels. The engine power is calculated from measured engine parameters (e.g. MAP, rpm, fuel flow, etc).

Disable Gas O2 Control: In natural gas mode, closed loop correction of air fuel ratio based on the Pre-catalyst O2 sensor is disabled.

Fault List Definitions

All the analog sensors in the PG-08 system have input sensor range faults. These are the coolant temperature sensor, fuel temperature sensor, throttle position sensors, pedal position sensors, manifold pressure sensor, HEGO sensors, and intake air temperature sensor. Signals to these sensors are converted into digital counts by the SECM. A low/high range sensor fault is normally set when the converted digital counts reach the minimum of 0 or the maximum of 1024 (**1024 = 5.0 Vdc with ~ 204 counts per volt**).

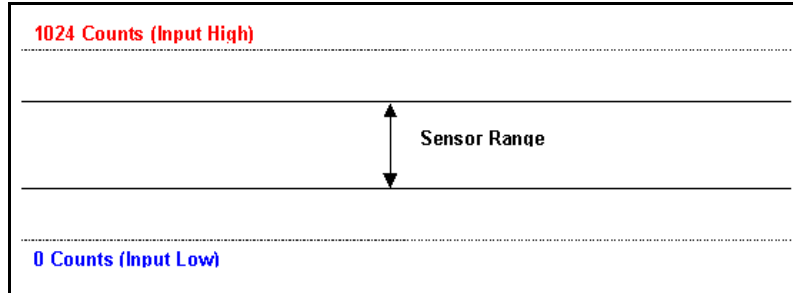

Additionally, the SECM includes software to learn the actual range of the pedal position and throttle position sensors in order to take full advantage of the sensor range. Faults are set if the learned values are outside of the normal expected range of the sensor (e.g. APP1AdaptLoMin).

Table 1. Fault List Definitions

FAULT	DESCRIPTION	CODE
APP1AdaptHiMax	Learned full pedal end of APP1 sensor range higher than expected	641
APP1AdaptHiMin	Learned full pedal end of APP1 sensor range lower than expected	651
APP1AdaptLoMax	Learned idle end of APP1 sensor range higher than expected	661
APP1AdaptLoMin	Learned idle end of APP1 sensor range lower than expected	631
APP1RangeHigh	APP1 sensor voltage out of range high, normally set if the APP1 signal has shorted to power or the ground for the sensor has opened	621
APP1RangeLow	APP1 sensor voltage out of range low, normally set if the APP1 signal has shorted to ground, circuit has opened or sensor has failed	611
APP2AdaptHiMax	Learned full pedal end of APP2 sensor range higher than expected	642

Table 1. Fault List Definitions (cont'd.)

FAULT	DESCRIPTION	CODE
APP2AdaptHiMin	Learned full pedal value of APP ₂ sensor range lower than expected	652
APP2AdaptLoMax	Learned idle value of APP ₂ sensor range higher than expected	662
APP2AdaptLoMin	Learned idle value of APP ₂ sensor range lower than expected	632
APP2RangeHigh	APP ₂ sensor voltage out of range high, normally set if the APP ₂ signal has shorted to power or the ground for the sensor has opened	622
APP2RangeLow	APP ₂ sensor voltage out of range low, normally set if the APP ₂ signal has shorted to ground, circuit has opened or sensor has failed	612
APP_Sensors_Conflict	APP position sensors do not track well, intermittent connections to APP or defective pedal assembly	691
CamEdgesFault	No CAM signal when engine is known to be rotating, broken CAM sensor leads or defective CAM sensor	191
CamSyncFault	Loss of synchronization on the CAM sensor, normally due to noise on the signal or an intermittent connection on the CAM sensor	192
CrankEdgesFault	No crankshaft signal when engine is known to be rotating, broken crankshaft sensor leads or defective crank sensor	193
CrankSyncFault	Loss of synchronization on the crankshaft sensor, normally due to noise on the signal or an intermittent connection on the crankshaft sensor	194
ECTOverTempFault	Engine Coolant Temperature is High. The sensor has measured an excessive coolant temperature typically due to the engine overheating.	161
ECTRangeHigh	Engine Coolant Temperature Sensor Input is High. Normally set if coolant sensor wire has been disconnected or circuit has opened to the SECM.	151

Table 1. Fault List Definitions (cont'd.)

FAULT	DESCRIPTION	CODE
ECTRangeLow	Engine Coolant Temperature Sensor Input is Low. Normally set if the coolant sensor wire has shorted to chassis ground or the sensor has failed.	141
ECT_IR_Fault	Engine Coolant Temperature not changing as expected	171
EST1_Open	EST1 output open, possibly open EST1 signal or defective spark module	421
EST1_Short	EST1 output shorted high or low, EST1 signal shorted to ground or power or defective spark module	431
ETCSpringTest	Electronic Throttle Control Spring Return Test has Failed. The SECM will perform a safety test of the throttle return spring following engine shutdown. If this spring has become weak the throttle will fail the test and set the fault. NOTE: Throttle assembly is not a serviceable item and can only be repaired by replacing the DV-EV throttle assembly.	481
ETC_Open_Fault	Electronic Throttle Control Driver has failed. Normally set if either of the ETC driver signals have opened or become disconnected, electronic throttle or SECM is defective.	471
ETC_Sticking	Electronic Throttle Control is Sticking. This can occur if the throttle plate (butterfly valve) inside the throttle bore is sticking. The plate sticking can be due to some type of obstruction; a loose throttle plate or worn components shaft bearings. NOTE: Throttle assembly is not a serviceable item and can only be repaired by replacing the DV-EV throttle assembly.	461
FuelSelectConflict	Conflict in fuel select signals, normally set if one or both of the fuel select signals are shorted to ground	181
FuelTempRangeHigh	Fuel Temperature Sensor Input is High. Normally set if the fuel temperature sensor wire has been disconnected or the circuit has opened to the SECM.	932
FuelTempRangeLow	Fuel Temperature Sensor Input is Low. Normally set if the fuel temperature sensor wire has shorted to chassis ground or the sensor has failed.	931
GasFuelAdaptRangeHi	In natural gas mode, system had to adapt lean more than expected	731
GasFuelAdaptRangeLo	In natural gas mode, system had to adapt rich more than expected	721
GasO2FailedLean	Pre-catalyst O ₂ sensor indicates extended lean operation on natural gas	751

Table 1. Fault List Definitions (cont'd.)

FAULT	DESCRIPTION	CODE
GasO2FailedRich	Pre-catalyst O ₂ sensor indicates extended rich operation on natural gas	771
GasO2NotActive	Pre-catalyst O ₂ sensor inactive on natural gas, open O ₂ sensor signal or heater leads, defective O ₂ sensor, or defective FTV	741
GasPostO2FailedRich	Post-catalyst O ₂ sensor control on natural gas has reached rich limit and sensor still reads too lean. This could be caused by oxygen leak before or just after sensor, catalyst failure, sensor failure, or wiring/relay failure causing the sensor to not be properly heated. If any Pre-O ₂ sensor faults are set, diagnose these first and after correcting these faults recheck if this fault sets.	772
GasPostO2FailedLean	Post-catalyst O ₂ sensor control on natural gas has reached lean limit and sensor still reads too rich. This could be caused by catalyst failure, sensor failure, or wiring/relay failure causing the sensor to not be properly heated. If any Pre-O ₂ sensor faults are set diagnose, these first and after correcting these faults recheck if this fault sets.	752
GasPostO2Inactive	Post-catalyst O ₂ sensor control on natural gas has sensed the O ₂ sensor is not responding as expected. If any Pre-O ₂ sensor faults are set diagnose these first and after correcting these faults recheck if this fault sets. Possible causes for this fault are sensor disconnected, sensor heater failed, sensor element failed, heater relay, or SECM control of heater relay is disconnected or failed.	742
HbridgeFault_ETC	(Electronic Throttle Control Driver has Failed) Indeterminate fault on Hbridge driver for Electronic Throttle Control. Possibly either ETC+ or ETC- driver signals have been shorted to ground	491
HardOverspeed	Engine speed has exceeded the third level (3 of 3) of overspeed protection	571

Table 1. Fault List Definitions (cont'd.)

FAULT	DESCRIPTION	CODE
IATRangeHigh	Intake Air Temperature Sensor Input is High normally set if the IAT temperature sensor wire has been disconnected, the circuit has opened to the SECM, or a short to Vbatt has occurred.	381
IATRangeLow	Intake Air Temperature Sensor Input is Low normally set if the IAT temperature sensor wire has shorted to chassis ground or the sensor has failed.	371
IAT_IR_Fault	Intake Air Temperature not changing as expected	391
LSDFault_CrankDisable	Crank Disable Fault, signal has opened or shorted to ground or power or defective crank disable relay	715
LSDFault_Dither1	Dither Valve 1 Fault, signal has opened or shorted to ground or power or defective dither 1 valve	711
LSDFault_Dither2	Dither Valve 2 Fault, signal has opened or shorted to ground or power or defective dither 2 valve	712
LSDFault_LockOff	Fuel lock off Valve Fault, signal has opened or shorted to ground or power or defective Fuel lock off valve	717
LSDFault_MIL	Malfunction Indicator Lamp Fault, signal has opened or shorted to ground or power or defective MIL lamp	718
LSeriesTrim	L-Series Trim Valve Fault. The L-Series trim valve has detected an internal fault.	733
LowOilPressureFault	Low engine oil pressure	521
MAPRangeHigh	Manifold Absolute Pressure Sensor Input is High, normally set if the TMAP pressure signal wire has become shorted to power, shorted to the IAT signal, the TMAP has failed or the SECM has failed.	342
MAPRangeLow	Manifold Absolute Pressure Sensor Input is Low, normally set if the TMAP pressure signal wire has been disconnected or shorted to ground or the circuit has opened to the SECM	332
MAPTimeRangeHigh	Manifold Absolute Pressure Sensor Input is High, normally set if the TMAP pressure signal wire has become shorted to power, shorted to the IAT signal, the TMAP has failed or the SECM has failed.	341

Table 1. Fault List Definitions (cont'd.)

FAULT	DESCRIPTION	CODE
MAPTimeRangeLow	Manifold Absolute Pressure Sensor Input is Low, normally set if the TMAP pressure signal wire has been disconnected or shorted to ground or the circuit has opened to the SECM	331
MAP_IR_HI	MAP sensor indicates higher pressure than expected	351
MAP_IR_LO	MAP sensor indicates lower pressure than expected	352
MAP_STICKING	MAP sensor not changing as expected	353
MediumOverspeed	Engine speed has exceeded the second level (2 of 3) of overspeed protection	572
O2RangeHigh	Pre-catalyst O ₂ sensor voltage out of range high, sensor signal shorted to power	921
O2RangeLow	Pre-catalyst O ₂ sensor voltage out of range low, sensor signal shorted to ground	911
O2_PostCatRangeHigh	Post-catalyst O ₂ sensor voltage out of range high, sensor signal shorted to voltage source (5V or battery)	922
O2_PostCatRangeLow	Post-catalyst O ₂ sensor voltage out of range low, sensor signal shorted to ground	912
SensVoltRangeHigh	Sensor reference voltage XDRP too high	561
SensVoltRangeLow	Sensor reference voltage XDRP too low	551
ServiceFault1	Service Interval 1 has been reached	991
ServiceFault2	Service Interval 2 has been reached	992
ServiceFault3	Service Interval 3 has been reached	993
ServiceFault4	Service Interval 4 has been reached—time to replace HEGO sensors	994
ServiceFault5	Service Interval 5 has been reached	995
SoftOverspeed	Engine speed has exceeded first level (1 of 3) of overspeed protection	573
SysVoltRangeHigh	System voltage too high	541
SysVoltRangeLow	System voltage too low	531

Table 1. Fault List Definitions (cont'd.)

FAULT	DESCRIPTION	CODE
TPS1AdaptHiMax	Learned WOT value of TPS ₁ sensor range higher than expected	251
TPS1AdaptHiMin	Learned WOT value of TPS ₁ sensor range lower than expected	271
TPS1AdaptLoMax	Learned closed throttle value of TPS ₁ sensor range higher than expected	281
TPS1AdaptLoMin	Learned closed throttle value of TPS ₁ sensor range lower than expected	241
TPS1RangeHigh	TPS ₁ sensor voltage out of range high, normally set if the TPS ₁ signal has shorted to power or ground for the sensor has opened	231
TPS1RangeLow	TPS ₁ sensor voltage out of range low, normally set if TPS ₁ signal has shorted to ground, circuit has opened or sensor has failed	221
TPS2AdaptHiMax	Learned WOT value of TPS ₂ sensor range higher than expected	252
TPS2AdaptHiMin	Learned WOT value of TPS ₂ sensor range lower than expected	272
TPS2AdaptLoMax	Learned closed throttle value of TPS ₂ sensor range higher than expected	282
TPS2AdaptLoMin	Learned closed throttle value of TPS ₂ sensor range lower than expected	242
TPS2RangeHigh	TPS ₂ sensor voltage out of range high, normally set if the TPS ₂ signal has shorted to power or ground for the sensor has opened	232
TPS2RangeLow	TPS ₂ sensor voltage out of range low, normally set if TPS ₂ signal has shorted to ground, circuit has opened or sensor has failed	222
TPS_Sensors_Conflict	TPS sensors differ by more than expected amount. NOTE: The TPS is not a serviceable item and can only be repaired by replacing the DV-EV throttle assembly	291

Table 2. Diagnostic Fault Codes (Flash Codes)

DFC	PROBABLE FAULT	FAULT ACTION *	CORRECTIVE ACTION FIRST CHECK
12	NONE Signifies the end of one pass through the fault list	NONE	None, used as end of the fault list identification
141	ECTRangeLow Coolant Sensor failure or shorted to GND	DelayedEngine Shutdown	Check ECT sensor connector and wiring for a short to GND SECM (Signal) Pin B15 To ECT Pin A SECM (Sensor GND) Pin B1 to ECT Pin B SECM (System GND) Pin A16, B17
151	ECTRangeHigh Coolant sensor disconnected or open circuit	DelayedEngine Shutdown	Check if ECT sensor connector is disconnected or for an open ECT circuit SECM (Signal) Pin B15 to ECT Pin A SECM (Sensor GND) Pin B1 to ECT Pin B
161	ECTOverTempFault Engine coolant temperature is high. The sensor has measured an excessive coolant temperature typically due to the engine overheating.	DelayedEngine Shutdown	Check coolant system for radiator blockage, proper coolant level and for leaks in the system. Possible ECT short to GND, check ECT signal wiring SECM (Signal) Pin B15 to ECT Pin A SECM (Sensor GND) Pin B1 to ECT Pin B SECM (System GND) Pin A16, B17 Check regulator for coolant leaks
171	ECT_IR_Fault Engine coolant temperature not changing as expected	NONE	Check for coolant system problems, e.g. defective or stuck thermostat
181	FuelSelectConflict Conflict in fuel select signals, normally set if both of the fuel select signals are shorted to ground	NONE	Check fuel select switch connection for a short to GND SECM (SIGNAL) Pin A12 SECM (SIGNAL) Pin A15 SECM (Sensor GND) Pin B1
191	CamEdgesFault No CAM signal when engine is known to be rotating, broken crankshaft sensor leads or defective CAM sensor	NONE	Check CAM sensor connections at ECM SECM (SIGNAL) Pin B10 to distributor connector Pin B SECM (Sensor GND) Pin B1 to distributor connector Pin A SECM 5V (PWR) to distributor connector Pin C Check for defective CAM sensor in distributor housing.

Table 2. Diagnostic Fault Codes (Flash Codes) cont'd.

DFC	PROBABLE FAULT	FAULT ACTION *	CORRECTIVE ACTION FIRST CHECK
192	CamSyncFault Loss of synchronization on the CAM sensor, normally due to noise on the signal or an intermittent connection on the CAM sensor	NONE	Check CAM sensor connections at distributor SECM (SIGNAL) Pin B10 to distributor connector Pin B SECM (Sensor GND) Pin B1 to distributor connector Pin A SECM 5V (PWR) to distributor connector Pin C Check for defective CAM sensor in distributor housing
193	CrankEdgesFault No crankshaft signal when engine is known to be rotating, broken crankshaft sensor leads or defective crank sensor	NONE	Check Crankshaft sensor connections SECM (SIGNAL) Pin B5 to Crank sensor Pin C SECM (Sensor GND) PIN B1 to Crank sensor Pin B SECM 5V (PWR) to Crank sensor Pin A Check for defective Crank sensor
194	CrankSyncFault Loss of synchronization on the crankshaft sensor, normally due to noise on the signal or an intermittent connection on the crankshaft sensor	NONE	Check Crankshaft sensor connections SECM (SIGNAL) Pin B5 to Crank sensor Pin C SECM (Sensor GND) Pin B1 to Crank sensor Pin B SECM 5V (PWR) to Crank sensor Pin A Check for defective Crank sensor
221	TPS1RangeLow TPS ₁ sensor voltage out of range low, normally set if the TPS ₁ signal has shorted to ground, circuit has opened or sensor has failed	(1) TurnOnMIL (2) CutThrottle	Check throttle connector connection and TPS ₁ sensor for an open circuit or short to GND SECM Pin B23 (signal) to ETC Pin 6 SECM Pin B1 (sensor GND) to ETC Pin 2 SECM (system GND) Pin A16, B17
222	TPS2RangeLow TPS ₂ sensor voltage out of range low, normally set if the TPS ₂ signal has shorted to ground, circuit has opened or sensor has failed	(1) TurnOnMIL (2) CutThrottle	Check throttle connector connection and TPS ₂ sensor for an open circuit or short to GND SECM Pin B4 (signal) to ETC Pin 5 SECM Pin B1 (sensor GND) to ETC Pin 2 SECM (system GND) Pin A16, B17

Table 2. Diagnostic Fault Codes (Flash Codes) cont'd.

DFC	PROBABLE FAULT	FAULT ACTION *	CORRECTIVE ACTION FIRST CHECK
231	TPS1RangeHigh TPS ₁ sensor voltage out of range high, normally set if the TPS ₁ signal has shorted to power or the ground for the sensor has opened	(1)TurnOn MIL (2)Cut Throttle	Check throttle connector and TPS ₁ sensor wiring for a shorted circuit SECM Pin B23 (signal) to ETC Pin 6 SECM Pin B1 (sensor GND) to ETC Pin 2
232	TPS2RangeHigh TPS ₂ sensor voltage out of range high, normally set if the TPS ₂ signal has shorted to power or the ground for the sensor has opened	(1)TurnOn MIL (2)Cut Throttle	Check throttle connector and TPS ₁ sensor wiring for a shorted circuit SECM Pin B4 (signal) to ETC Pin 5 SECM pin B1 (sensor GND) to ETC Pin 2
241	TPS1AdaptLoMin Learned closed throttle value of TPS ₁ sensor range lower than expected	NONE	Check the throttle connector and pins for corrosion. To check the TPS disconnect the throttle connector and measure the resistance from: TPS Pin 2 (GND) to Pin 6 (TPS ₁ SIGNAL) (0.7 Ω ± 30%) TPS Pin 3 (PWR) to Pin 6 (TPS ₁ SIGNAL) (1.4 Ω ± 30%)
242	TPS2AdaptLoMin Learned closed throttle value of TPS ₂ sensor range lower than expected	NONE	Check the throttle connector and pins for corrosion. To check the TPS disconnect the throttle connector and measure the resistance from: TPS Pin 2 (GND) to Pin 5 (TPS ₂ SIGNAL) (1.3K Ω ± 30%) TPS PIN 3 (PWR) to PIN 5 (TPS ₂ SIGNAL) (0.6K Ω ± 30%)
251	TPS1AdaptHiMax Learned WOT value of TPS ₁ sensor range higher than expected	NONE	N/A
252	TPS2AdaptHiMax Learned WOT value of TPS ₂ sensor range higher than expected	NONE	N/A
271	TPS1AdaptHiMin Learned WOT value of TPS ₁ sensor range lower than expected	NONE	N/A
272	TPS2AdaptHiMin Learned WOT value of TPS ₂ sensor range lower than expected	NONE	N/A

Table 2. Diagnostic Fault Codes (Flash Codes) cont'd.

DFC	PROBABLE FAULT	FAULT ACTION *	CORRECTIVE ACTION FIRST CHECK
281	TPS1AdaptLoMax Learned closed throttle value of TPS ₁ sensor range higher than expected	NONE	N/A
282	TPS2AdaptLoMax Learned closed throttle value of TPS ₂ sensor range higher than expected	NONE	N/A
291	TPS_Sensors_Conflict TPS sensors differ by more than expected amount NOTE: The TPS is not a serviceable item and can only be repaired by replacing the DV-EV throttle assembly.	(1) TurnOn MIL (2) Engine Shutdown	Perform checks for DFCs 241 & 242
331	MAPTimeRangeLow Manifold Absolute Pressure sensor input is low, normally set if the TMAP pressure signal wire has been disconnected or shorted to ground or the circuit has opened to the SECM	TurnOnMIL	Check TMAP connector and MAP signal wiring for an open circuit TMAP Pin 4 to SECM Pin B18 (signal) TMAP Pin 1 to SECM Pin B1 (sensor GND) TMAP Pin 3 to SECM Pin B24 (PWR) Check the MAP sensor by disconnecting the TMAP connector and measuring at the sensor: TMAP Pin 1(GND) to Pin 4 (pressure signal kPa) (2.4kΩ - 8.2kΩ) TMAP Pin 3 (PWR) to Pin 4 (pressure signal kPa) (3.4kΩ - 8.2kΩ)

Table 2. Diagnostic Fault Codes (Flash Codes) cont'd.

DFC	PROBABLE FAULT	FAULT ACTION *	CORRECTIVE ACTION FIRST CHECK
332	<p>MAPRangeLow Manifold Absolute Pressure sensor input is low, normally set if the TMAP pressure signal wire has been disconnected or shorted to ground or the circuit has opened to the SECM</p>	TurnOnMIL	<p>Check TMAP connector and MAP signal wiring for an open circuit TMAP Pin 4 to SECM Pin B18 (signal) TMAP Pin 1 to SECM Pin B1 (sensor GND) TMAP Pin 3 to SECM Pin B24 (PWR) Check the MAP sensor by disconnecting the TMAP connector and measuring at the sensor: TMAP Pin 1(GND) to Pin 4 (pressure signal kPa) (2.4kΩ - 8.2kΩ) TMAP Pin 3 (power) to Pin 4 (pressure signal kPa) (3.4kΩ - 8.2kΩ)</p>
341	<p>MAPTimeRangeHigh Manifold Absolute Pressure Sensor Input is High, normally set if the TMAP pressure signal wire has become shorted to power, shorted to the IAT signal, the TMAP has failed or the SECM has failed.</p>	TurnOnMIL	<p>Check TMAP connector and MAP signal wiring for a shorted circuit TMAP Pin 4 to SECM Pin B18 (signal) TMAP Pin 1 to SECM Pin B1 (sensor GND) TMAP Pin 3 to SECM Pin B24 (PWR) Check the MAP sensor by disconnecting the TMAP connector and measuring at the sensor: TMAP Pin 1(GND) to Pin 4 (pressure signal kPa) (2.4kΩ - 8.2kΩ) TMAP Pin 3 (power) to Pin 4 (pressure signal kPa) (3.4kΩ - 8.2kΩ)</p>
342	<p>MAPRangeHigh Manifold Absolute Pressure Sensor Input is High, normally set if the TMAP pressure signal wire has become shorted to power, shorted to the IAT signal, the TMAP has failed or the SECM has failed</p>	TurnOnMIL	<p>Check TMAP connector and MAP signal wiring for a shorted circuit TMAP Pin 4 to SECM Pin B18 (signal) TMAP Pin 1 to SECM Pin B1 (sensor GND) TMAP Pin 3 to SECM Pin B24 (PWR) Check the MAP sensor by disconnecting the TMAP connector and measuring at the sensor: TMAP Pin 1(GND) to Pin 4 (pressure signal kPa) (2.4kΩ - 8.2kΩ) TMAP Pin 3 (power) to Pin 4 (pressure signal kPa) (3.4kΩ - 8.2kΩ)</p>

Table 2. Diagnostic Fault Codes (Flash Codes) cont'd.

DFC	PROBABLE FAULT	FAULT ACTION *	CORRECTIVE ACTION, FIRST CHECK
351	MAP_IR_HI MAP sensor indicates higher pressure than expected	TurnOnMIL	Check for vacuum leaks. Check that TMAP sensor is mounted properly. Possible defective TMAP sensor.
352	MAP_IR_LO MAP sensor indicates lower pressure than expected	TurnOnMIL	Possible defective TMAP sensor.
353	MAP_STICKING MAP sensor not changing as expected	TurnOnMIL	Check that TMAP sensor is mounted properly. Possible defective TMAP sensor.
371	IATRangeLow Intake Air Temperature Sensor Input is Low normally set if the IAT temperature sensor wire has shorted to chassis ground or the sensor has failed.	TurnOnMIL	Check TMAP connector and IAT signal wiring for a shorted circuit TMAP Pin 2 to SECM Pin B12 (signal) TMAP Pin 1 to SECM Pin B1 (sensor GND) To check the IAT sensor of the TMAP disconnect the TMAP connector and measure the IAT resistance Resistance is approx 2400 ohms at room temperature.
381	IATRangeHigh Intake Air Temperature Sensor Input is High normally set if the IAT temperature sensor wire has been disconnected or the circuit has opened to the SECM.	TurnOnMIL	Check TMAP connector and IAT signal wiring for a shorted circuit TMAP Pin 2 to SECM Pin B12 (signal) TMAP Pin 1 to SECM Pin B1 (sensor GND) To check the IAT sensor of the TMAP disconnect the TMAP connector and measure the IAT resistance Resistance is approx 2400 ohms at room temperature.
391	IAT_IR_Fault Intake Air Temperature not changing as expected	NONE	Check connections to TMAP sensor. Check that TMAP sensor is properly mounted to manifold.
421	EST1_Open EST1 output open, possibly open EST1 signal or defective spark module	TurnOnMIL	Check ignition module wiring and connector for open circuit SECM Pin A9 (EST1) to ignition module Pin B. Verify GND on ignition module Pin C Verify +12 Vdc on ignition module Pin A Refer to application manual for specific engine details.

Table 2. Diagnostic Fault Codes (Flash Codes) cont'd.

DFC	PROBABLE FAULT	FAULT ACTION *	CORRECTIVE ACTION FIRST CHECK
431	EST1_Short EST1 output shorted high or low, EST1 signal shorted to ground or power or defective spark module	TurnOnMIL	Check ignition module wiring and connector for shorts SECM Pin A9 (EST1) to ignition module Pin B Verify GND on ignition module Pin C Verify +12 Vdc on ignition module Pin A Refer to application manual for specific engine details.
461	ETC_Sticking Electronic Throttle Control is sticking. This can occur if the throttle plate (butterfly valve) inside the throttle bore is sticking. The plate sticking can be due to some type of obstruction, a loose throttle plate, or worn components shaft bearings. NOTE: The throttle assembly is not a serviceable item and can only be repaired by replacing the DV-EV throttle assembly.	(1) TurnOnMIL (2) EngineShut down (3) CutThrottle	Check for debris or obstructions inside the throttle body <ul style="list-style-type: none"> Check throttle-plate shaft for bearing wear Check the ETC driver wiring for an open circuit SECM Pin A17 to ETC + Pin 1 SECM Pin A18 to ETC - Pin 4 Check the ETC internal motor drive by disconnecting the throttle connector and measuring the motor drive resistance at the throttle ETC Pin 1 (+DRIVER) to Pin 4 (-DRIVER) ~3.0-4.0Ω
471	ETC_Open_Fault Electronic Throttle Control Driver has failed, normally set if either of the ETC driver signals have opened or become disconnected, electronic throttle or SECM is defective.	TurnOnMIL	Check the ETC driver wiring for an open circuit SECM Pin A17 to ETC + Pin 1 SECM Pin A18 to ETC - Pin 4 Check the ETC internal motor drive by disconnecting the throttle connector and measuring the motor drive resistance at the throttle ETC Pin 1 (+DRIVER) to Pin 4 (-DRIVER) ~3.0-4.0Ω
491	HbridgeFault_ETC Electronic Throttle Control Driver has failed. Indeterminate fault on Hbridge driver for electronic throttle control. Possibly either ETC+ or ETC- driver signals have been shorted to ground	TurnOnMIL	Check ETC driver wiring for a shorted circuit SECM Pin A17 to ETC + Pin 1 SECM Pin A18 to ETC - Pin 4 Check the ETC internal motor drive by disconnecting the throttle connector and measuring the motor drive resistance at the throttle ETC Pin 1 (+DRIVER) to Pin 4 (-DRIVER) ~3.0-4.0Ω

Table 2. Diagnostic Fault Codes (Flash Codes) cont'd.

DFC	PROBABLE FAULT	FAULT ACTION *	CORRECTIVE ACTION FIRST CHECK
521	LowOilPressureFault Low engine oil pressure	DelayedEngine Shutdown	Check engine oil level Check electrical connection to the oil pressure switch SECM Pin B9 to Oil Pressure Switch
531	SysVoltRangeLow System voltage too low	TurnOnMIL	Check battery voltage <ul style="list-style-type: none"> Perform maintenance check on electrical connections to the battery and chassis ground Check battery voltage during starting and when the engine is running to verify charging system and alternator function Measure battery power at SECM with a multimeter (with key on) SECM Pin A23 (DRVP) to SECM Pin A16 (DRVG) SECM Pin A23 (DRVP) to SECM Pin B17 (DRVG)
541	SysVoltRangeHigh System voltage too high	DelayedEngine Shutdown	Check battery and charging system voltage <ul style="list-style-type: none"> Check battery voltage during starting and when the engine is running Check voltage regulator, alternator, and charging system Check battery and wiring for overheating and damage Measure battery power at SECM with a multimeter (with key on) SECM Pin A23 (DRVP) to SECM Pin A16 (DRVG) SECM Pin A23 (DRVP) to SECM Pin B17 (DRVG)

Table 2. Diagnostic Fault Codes (Flash Codes) cont'd.

DFC	PROBABLE FAULT	FAULT ACTION *	CORRECTIVE ACTION FIRST CHECK
551	SensVoltRangeLow Sensor reference voltage XDRP too low	EngineShutdown	<p>Measure transducer power at the TMAP connector with a multimeter TMAP Pin 3 (PWR) to TMAP Pin 1 (sensor GND)</p> <p>Verify transducer power at the SECM with a multimeter SECM Pin B24 (PWR) to SECM Pin B1 (sensor GND)</p> <p>Verify transducer power at ETC with a multimeter ETC Pin 3 (PWR) to ETC Pin 2 (sensor GND)</p> <p>Verify transducer power to the foot pedal with a multimeter.</p>
561	SensVoltRangeHigh Sensor reference voltage XDRP too high	EngineShutdown	<p>Measure transducer power at the TMAP connector with a multimeter TMAP Pin 3 (PWR) to TMAP Pin 1 (sensor GND)</p> <p>Verify transducer power at the SECM with a multimeter SECM Pin B24 (PWR) to SECM Pin B1 (sensor GND)</p> <p>Verify transducer power at ETC with a multimeter ETC Pin 3 (PWR) to ETC Pin 2 (sensor GND)</p> <p>Verify transducer power to the foot pedal with a multimeter.</p>
571	HardOverspeed Engine speed has exceeded the third level (3 of 3) of overspeed protection	(1) HardRevLimit (2) EngineShutdown	<p>Usually associated with additional ETC faults</p> <ul style="list-style-type: none"> Check for ETC Sticking or other ETC faults <p>Verify if the lift truck was motored down a steep grade</p>
572	MediumOverspeed Engine speed has exceeded the second level (2 of 3) of overspeed protection	MediumRevLimit	<p>Usually associated with additional ETC faults</p> <ul style="list-style-type: none"> Check for ETC Sticking or other ETC faults
573	SoftOverspeed Engine speed has exceeded the first level (1 of 3) of overspeed protection	SoftRevLimit	<p>Usually associated with additional ETC faults</p> <ul style="list-style-type: none"> Check for ETC Sticking or other ETC faults
621	APP1RangeHigh APP ₁ sensor voltage out of range high, normally set if the APP ₁ signal has shorted to power or the ground for the sensor has opened	NONE	<p>Check foot pedal connector</p> <ul style="list-style-type: none"> Check APP₁ signal at SECM PIN B7

Table 2. Diagnostic Fault Codes (Flash Codes) cont'd.

DFC	PROBABLE FAULT	FAULT ACTION *	CORRECTIVE ACTION FIRST CHECK
717	LSDFault_LockOff Fuel lock off Valve Fault, signal has opened or shorted to ground or power or defective Fuel lock off valve	TurnOnMIL	Check fuel lock off valve for an open wire or connector being disconnected or signal shorted to GND Lockoff Pin B (signal) to SECM Pin A11 Lockoff Pin A (power) to SECM (DRVP) Pin A23 Check CSV for an open coil by disconnecting the CSV connector and measuring the resistance ($\sim 26\Omega \pm 3\Omega$)
718	LSDFault_MIL Malfunction Indicator Lamp Fault, signal has opened or shorted to ground or power or defective MIL lamp	NONE	Check MIL lamp for an open wire or short to GND.
721	GasFuelAdaptRangeLo In natural gas mode, system had to adapt rich more than expected	(1) TurnOnMIL (2) DisableGasO2Ctrl (3) DisableGasPostO2Ctrl	Check for vacuum leaks. Check fuel trim valves, e.g. leaking valve or hose Check for missing orifice(s).
731	GasFuelAdaptRangeHi In natural gas mode, system had to adapt lean more than expected	(1) TurnOnMIL (2) DisableGasO2Ctrl (3) DisableGasPostO2Ctrl	Check fuel trim valves, e.g. plugged valve or hose. Check for plugged orifice(s).
733	LSeriesTrim	(1) TurnOnMIL (2) DisableGasO2Ctrl (3) DisableGasPostO2Ctrl	Inspect trim valve for damage Check wiring to trim valve Check connection between SECM and Trim valve
741	GasO2NotActive Pre-catalyst O ₂ sensor inactive on natural gas, open O ₂ sensor signal or heater leads, defective O ₂ sensor	(1) TurnOnMIL (2) DisableGasO2Ctrl (3) DisableGasPostO2Ctrl	Check that Pre-catalyst O ₂ sensor connections are OK. O ₂ (signal) Pin B to SECM Pin B13 O ₂ Pin C (GND) to SECM (DRVG GND) Pins A16, B17 O ₂ Pin 1 (power) to SECM (DRVP + 12V) Pin A23 Verify O ₂ sensor heater circuit is operating by measuring heater resistance ($2.1\Omega \pm 0.4\Omega$) O ₂ Pin C (GND) to Pin D (power)

Table 2. Diagnostic Fault Codes (Flash Codes) cont'd.

DFC	PROBABLE FAULT	FAULT ACTION *	CORRECTIVE ACTION FIRST CHECK
742	GasPostO2NotActive Post-catalyst O ₂ sensor inactive on natural gas, open O ₂ sensor signal or heater leads, defective O ₂ sensor.	(1) TurnOnMIL (2) DisableGasPostO2Ctrl	Check that Post-catalyst O ₂ sensor connections are OK. O ₂ (signal) Pin B to SECM Pin B19 O ₂ Pin C (GND) to SECM (DRVG GND) Pins A16, B17 O ₂ Pin D (power) to Post O ₂ Heater Relay. Relay pin 87. This relay only turns on after engine has been running for some time and SECM has calculated that water condensation in exhaust has been removed by exhaust heat. Post O ₂ Heater Relay has SECM (DRVP + 12V) applied to the relay coil power. The relay coil ground is controlled by SECM Pin A20 to activate the relay to flow current through the post O ₂ heater. Verify O ₂ sensor heater circuit is operating by measuring heater resistance (2.1Ω ± 0.4Ω) O ₂ Pin C (GND) to Pin D (power)
751	GasO2FailedLean Pre-catalyst O ₂ sensor indicates extended lean operation on natural gas	(1) TurnOnMIL (2) DisableGasO2Ctrl	Check for vacuum leaks. Check fuel trim valves, e.g. leaking valve or hose. Check for missing orifice(s).
752	GasPostO2FailedLean Post-catalyst O ₂ sensor indicates extended lean operation on natural gas	(1) TurnOnMIL (2) DisableGasPostO2Ctrl	Correct other faults that may contribute to 752 (e.g. faults pertaining to fuel trim valves, Pre-Cat O ₂ , Post Cat O ₂ sensor) Check for vacuum leaks Check for leaks in exhaust, catalytic converter, HEGO sensors; repair leaks. Check all sensor connections (see fault 742 corrective actions).
771	GasO2FailedRich Pre-catalyst O ₂ sensor indicates extended rich operation on natural gas	(1) TurnOnMIL (2) DisableGasO2Ctrl	Check fuel trim valves, e.g. plugged valve or hose. Check for plugged orifice(s).

Table 2. Diagnostic Fault Codes (Flash Codes) cont'd.

DFC	PROBABLE FAULT	FAULT ACTION *	CORRECTIVE ACTION FIRST CHECK
772	GasPostO2FailedRich Pre-catalyst O ₂ sensor indicates extended rich operation on natural gas	(1) TurnOnMIL (2) DisableGasPostO2Ctrl	Correct other faults that may contribute to 772 (e.g. faults pertaining to FTV, Pre-Cat O ₂ , Post Cat O ₂ sensor) Look for leaks in exhaust, catalytic converter, HEGO sensors; repair leaks. Check all sensor connections (see fault 742 corrective actions).
911	O2RangeLow Pre-catalyst O ₂ sensor voltage out of range low, sensor signal shorted to ground	(1) TurnOnMIL (2) DisableGasO2Ctrl	Check if O ₂ sensor installed before the catalyst is shorted to GND or sensor GND. O ₂ (signal) Pin B to SECM Pin B13 SECM (DRVG GND) Pins A16, B17 SECM (sensor GND) Pin B1
912	O2_PostCatRangeLow Post-catalyst O ₂ sensor voltage out of range low, sensor signal shorted to ground	(1) TurnOnMIL (2) DisableGasPostO2Ctrl	Check if O ₂ installed after the catalyst sensor is shorted to GND or sensor GND. O ₂ (signal) Pin B to SECM Pin B19 Possible sources: SECM (DRVG GND) Pins A16, B17 and SECM (sensor GND) Pin B1
921	O2RangeHigh Pre-catalyst O ₂ sensor voltage out of range high, sensor signal shorted to power	(1) TurnOnMIL (2) DisableGasO2Ctrl	Check if O ₂ sensor installed before catalyst is shorted to +5Vdc or battery. O ₂ (signal) Pin B to SECM Pin B13 SECM (PWR) Pin B24 SECM (power) Pin A23
922	O2_PostCatRangeHigh Post-catalyst O ₂ sensor voltage out of range low, sensor signal shorted to ground	(1) TurnOnMIL (2) DisableGasPostO2Ctrl	Check if O ₂ sensor installed after catalyst is shorted to +5Vdc or battery. O ₂ (signal) Pin B to SECM Pin B19 Possible voltage sources: SECM (PWR) Pin B24 and SECM (power) Pin A23

Table 2. Diagnostic Fault Codes (Flash Codes) cont'd.

DFC	PROBABLE FAULT	FAULT ACTION *	CORRECTIVE ACTION FIRST CHECK
994	ServiceFault4 Service Interval 4 has been reached—replace HEGO sensors	TurnOnMIL	Replace Pre-catalyst HEGO sensor Replace Post-catalyst HEGO sensor

THIS PAGE INTENTIONALLY LEFT BLANK

Chapter 8. Parts Description

Fuel System Components

The chart below lists the PG-08 components required for a 8.1L engine operating on natural gas fuel.

PART NO.	DESCRIPTION	QTY
1751-6068	Engine Control Module (SECM 48-pin)	1
12596851	Crankshaft Position Sensor	1
1689-1033	TMAP Sensor	1
1680-6005	Oxygen Sensors	2
15326386	Coolant Sensor	1
12574403	Engine Oil Pressure Sensor	1
8404-3004	L-Series Trim Valve 22mm	1
•	Ignition Coils	8
8215G030-12V	Fuel Lock Off Solenoid	1
1326-4061	Maxitrol 210DZ Regulator	1
4601-3009	D100 Venturi Mixer	1
6945-5017	Throttle-DV-E5 68mm	1
•	Throttle Hose	1
840-350	Hose Clamps	2

Maxitrol 210DZ Regulator

This 210DZ regulator is supplied from an outside vendor as a complete assembly. It has no serviceable parts. If it tests defective, replace the entire regulator with the specified replacement assembly. The Maxitrol regulator is specifically engineered for the PG-08 system and cannot be replaced by a standard Maxitrol 210DZ regulator.



NOTE

The PG-08 system will malfunction if the incorrect regulator is substituted in the system. Please contact Buck's Engines for the correct replacement part.

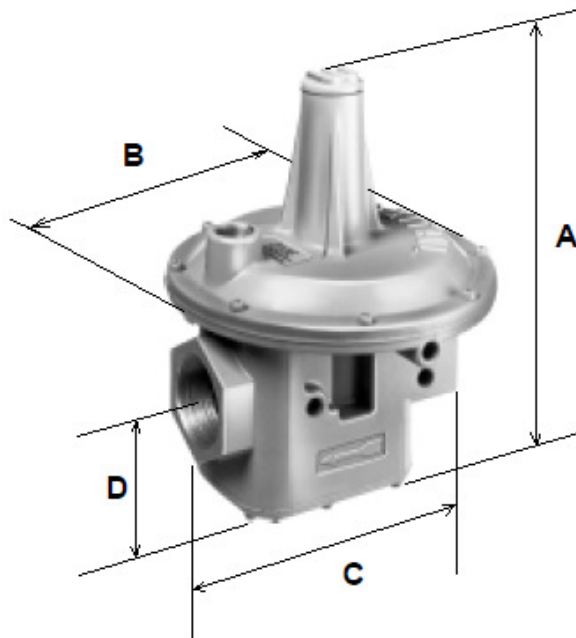

Swing Radius	5-7/16" (138.1mm)
Dimension A	9" (228.6mm)
Dimension B	7" (177.8mm)
Dimension C	6" (152.4mm)
Dimension D	2-3/8" (60.3mm)

ACFM	Actual cubic feet per minute at the specified suction conditions
AFR	Air fuel ratio
BHP	Brake horsepower
BTU	British Thermal Unit
Bi-Fuel	Able to operate on either of two fuels
CTS	Coolant temperature sensor
CNG	Compressed natural gas
Dual Fuel	Able to run simultaneously on two fuels, e.g. diesel and natural gas. Often this term is incorrectly used to describe bi-fuel operation. Spark-ignited engines are typically bi-fuel while compression ignition engines are dual-fuel.
ECM	Engine control module
FPP	Foot pedal position
FPV	Fuel primer valve
FTV	Fuel trim valve
GPM	Gallons per minute of flow
HEGO	Heated exhaust gas oxygen (sensor)
LAT	Limited-angle torque motor
MAP	Manifold absolute pressure
MAT	Manifold air temperature
MIL	Malfunction indicator lamp
MOR	Manufacturer of record for emissions certification on the engine
NG	Natural gas
NSPS	New Source Performance Standards effective in 2008 for stationary spark-ignited engines.
OEM	Original equipment manufacturer
PHI	Relative fuel-air ratio or percent of stoichiometric fuel (actual fuel-air ratio / stoichiometric fuel-air ratio)
RPM	Revolutions per minute
SECM	Small engine control module
TMAP	Temperature and manifold absolute pressure
TPS	Throttle position sensor
VDC	Voltage of direct current type
VE	Compressed natural gas
WOT	Wide open throttle

